

SAMSUNG

TFT-LCD MONITOR

**GH17LS
GH17ES**

SERVICE *Manual*

TFT-LCD MONITOR

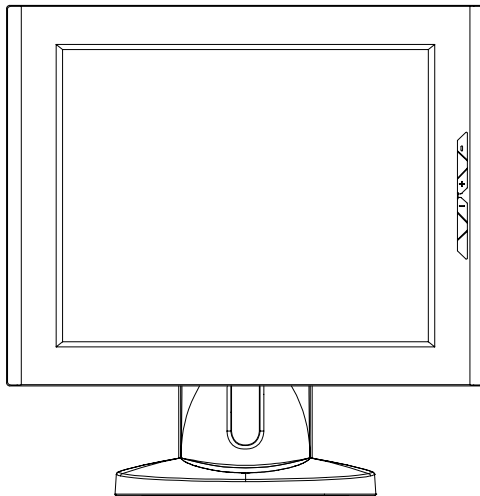

CONTENTS

1. Precautions
2. Product Specifications
3. Disassembly & Reassembly
4. Alignments & Adjustments
5. Troubleshooting
6. Exploded View & Parts List
7. Electrical Parts List
8. Block Diagram
9. Wiring Diagram
10. Schematic Diagrams
11. Panel Description



Samsung Electronics Co.,Ltd.

416, Maetan-3Dong, Paldal-Gu, Suwon City, Kyungki-Do, Korea.

Printed in Korea

P/N : BN68-00225C-00

<http://www.samsungmonitor.com> (SyncMaster Worldwide)

<http://www.samsung-monitor.com> (SyncMaster USA)

<http://www.sec.co.kr/monitor> (Korea)

Copyright

© 2001 by Samsung Electronics Co., Ltd.

All rights reserved.

This manual may not, in whole or in part, be copied, photocopied, reproduced, translated, or converted to any electronic or machine readable form without prior written permission of Samsung Electronics Co., Ltd.

GH17LS/GH17ES Service Manual

First edition July 2001.

Printed in Korea.

Trademarks

Samsung is the registered trademark of Samsung Electronics Co., Ltd.

GH17LS/GH17ES and MacMaster Cable Adapter are trademarks of Samsung Electronics Co., Ltd.

Macintosh, Centris, Quadra, Duo Douk, and Power Macintosh are trademarks of Apple Computer, Inc.

All other trademarks are the property of their respective owners.

1 Precautions

Follow these safety, servicing and ESD precautions to prevent damage and to protect against potential hazards such as electrical shock.

1-1 Safety Precautions

1-1-1 Warnings

1. For continued safety, do not attempt to modify the circuit board.
2. Disconnect the AC power and DC power jack before servicing.

1-1-2 Servicing the LCD Monitor

1. When servicing the LCD Monitor, Disconnect the AC line cord from the AC outlet.
2. It is essential that service technicians have an accurate voltage meter available at all times. Check the calibration of this meter periodically.

1-1-3 Fire and Shock Hazard

Before returning the monitor to the user, perform the following safety checks:

1. Inspect each lead dress to make certain that the leads are not pinched or that hardware is not lodged between the chassis and other metal parts in the monitor.
2. Inspect all protective devices such as nonmetallic control knobs, insulating materials, cabinet backs, adjustment and compartment covers or shields, isolation resistor-capacitor networks, mechanical insulators, etc.
3. Leakage Current Hot Check (Figure 1-1):

WARNING:

Do not use an isolation transformer during this test.

Use a leakage current tester or a metering system that complies with American National Standards Institute (ANSI C101.1, *Leakage Current for Appliances*), and Underwriters Laboratories (UL Publication UL1410, 59.7).

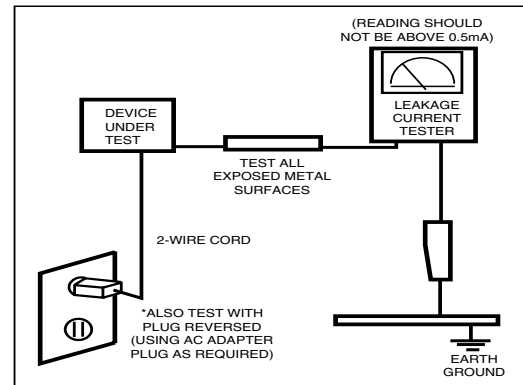

Figure 1-1. Leakage Current Test Circuit

4. With the unit completely reassembled, plug the AC line cord directly into a 120V AC outlet. With the unit's AC switch first in the ON position and then OFF, measure the current between a known earth ground (metal water pipe, conduit, etc.) and all exposed metal parts, including: metal cabinets, screwheads and control shafts. The current measured should not exceed 0.5 milliamp. Reverse the power-plug prongs in the AC outlet and repeat the test.

1-1-4 Product Safety Notices

Some electrical and mechanical parts have special safety-related characteristics which are often not evident from visual inspection. The protection they give may not be obtained by replacing them with components rated for higher voltage, wattage, etc. Parts that have special safety characteristics are identified by ⚠ on schematics and parts lists. A substitute replacement that does not have the same safety characteristics as the recommended replacement part might create shock, fire and / or other hazards. Product safety is under review continuously and new instructions are issued whenever appropriate.

1-2 Servicing Precautions

WARNING: An electrolytic capacitor installed with the wrong polarity might explode.

Caution: Before servicing units covered by this service manual, read and follow the Safety Precautions section of this manual.

Note: If unforeseen circumstances create conflict between the following servicing precautions and any of the safety precautions, always follow the safety precautions.

1-2-1 General Servicing Precautions

1. Always unplug the unit's AC power cord from the AC power source and disconnect the DC Power Jack before attempting to:
 - (a) remove or reinstall any component or assembly,
 - (b) disconnect PCB plugs or connectors, (c) connect a test component in parallel with an electrolytic capacitor.
2. Some components are raised above the printed circuit board for safety. An insulation tube or tape is sometimes used. The internal wiring is sometimes clamped to prevent contact with thermally hot components. Reinstall all such elements to their original position.
3. After servicing, always check that the screws, components and wiring have been correctly reinstalled. Make sure that the area around the serviced part has not been damaged.
4. Check the insulation between the blades of the AC plug and accessible conductive parts (examples: metal panels, input terminals and earphone jacks).
5. Insulation Checking Procedure: Disconnect the power cord from the AC source and turn the power switch ON. Connect an insulation resistance meter (500 V) to the blades of the AC plug.
The insulation resistance between each blade of the AC plug and accessible conductive parts (see above) should be greater than 1 megohm.
6. Always connect a test instrument's ground lead to the instrument chassis ground before connecting the positive lead; always remove the instrument's ground lead last.

1-3 Electrostatically Sensitive Devices (ESD) Precautions

Some semiconductor (solid state) devices can be easily damaged by static electricity. Such components are commonly called Electrostatically Sensitive Devices (ESD). Examples of typical ESD devices are integrated circuits and some field-effect transistors. The following techniques will reduce the incidence of component damage caused by static electricity.

1. Immediately before handling any semiconductor components or assemblies, drain the electrostatic charge from your body by touching a known earth ground. Alternatively, wear a discharging wrist-strap device. To avoid a shock hazard, be sure to remove the wrist strap before applying power to the monitor.
2. After removing an ESD-equipped assembly, place it on a conductive surface such as aluminum foil to prevent accumulation of an electrostatic charge.
3. Do not use freon-propelled chemicals. These can generate electrical charges sufficient to damage ESDs.
4. Use only a grounded-tip soldering iron to solder or desolder ESDs.
5. Use only an anti-static solder removal device. Some solder removal devices not classified as "anti-static" can generate electrical charges sufficient to damage ESDs.
6. Do not remove a replacement ESD from its protective package until you are ready to install it. Most replacement ESDs are packaged with leads that are electrically shorted together by conductive foam, aluminum foil or other conductive materials.
7. Immediately before removing the protective material from the leads of a replacement ESD, touch the protective material to the chassis or circuit assembly into which the device will be installed.
Caution: Be sure no power is applied to the chassis or circuit and observe all other safety precautions.
8. Minimize body motions when handling unpackaged replacement ESDs. Motions such as brushing clothes together, or lifting your foot from a carpeted floor can generate enough static electricity to damage an ESD.

2 Product Specifications

2-1 Specifications

Item	Description	
	GH17LS	GH17ES
LCD Panel	TFT-LCD panel, RGB vertical stripe, normally black transmissive, 17-Inch viewable, 0.264 (H) x 0.264 (V) mm pixel pitch	
Scanning Frequency	Horizontal : 30 kHz ~ 81 kHz (Automatic) Vertical : 56 Hz ~ 85 Hz (~XGA), 76 Hz (SXGA); GH17ES	Vertical : 56 Hz ~ 76 Hz; GH17LS
Display Colors	16,7 Million colors	
Maximum Resolution	Horizontal : 1280 Pixels Vertical : 1024 Pixels	
Input Video Signal	Analog, 0.714 Vp-p \pm 5% positive at 75 Ω , internally terminated	
Input Sync Signal	Type : Seperate H/V sync, Composite H/V, Sync-on-Green Level : TTL level (V high \geq 2.0 V, V low \leq 0.8 V), Sync-on-Green (\leq -0.25 V)	
Maximum Pixel Clock rate	135 MHz	
Active Display Horizontal/Vertical	338 \pm 3 mm/270 \pm 3 mm	
AC power voltage & Frequency	AC 90 ~ 264 Volts, 60/50 Hz \pm 3 Hz	
Power Consumption	42 W (max), 40W (normal)	
Dimensions Unit (W x D x H) Carton (W x D x H)	17.5 x 18.0 x 8.2 Inches (444 x 457 x 208.4 mm) 20.7 x 10.7 x 20.9 Inches (527 x 271 x 532 mm)	
Weight (Net/Gross)	5.4 kg (11.9 lbs) / 7.9 kg (17.4 lbs)	5.8 kg (12.8 lbs) / 8.3 kg (18.3 lbs)
Environmental Considerations	Operating Temperature : 50°F ~ 104°F (10°C ~ 35°C) Humidity : 10 % ~ 80 % Storage Temperature : -68°F ~ 113°F (-20°C ~ 45°C) Humidity : 5 % ~ 95 %	
<ul style="list-style-type: none"> • GH17LS/GH17ES comply with SWEDAC (MPRII) recommendations for reduced electromagnetic fields. • Designs and specifications are subject to change without prior notice. 		

2-2 Pin Assignments

Pin No.	Sync Type	15-Pin D-Sub Signal Cable Connector		
		Separate	Composite	Sync-on-green
1		Red	Red	Red
2		Green	Green	Green + H/V Sync.
3		Blue	Blue	Blue
4		GND	GND	GND
5		DDC Return (GND)	DDC Return (GND)	DDC Return (GND)
6		GND-R	GND-R	GND-R
7		GND-G	GND-G	GND-G
8		GND-B	GND-B	GND-B
9		DDC Power Input (+5V)	DDC Power Input (+5V)	DDC Power Input (+5V)
10		Self Raster	Self Raster	Self Raster
11		GND	GND	GND
12		Bi-Dr Data (SDA)	Bi-Dr Data (SDA)	Bi-Dr Data (SDA)
13		H-Sync.	H/V-Sync.	Not Used
14		V-Sync.	Not Used	Not Used
15		DDC Clock (SCL)	DDC Clock (SCL)	DDC Clock (SCL)

2-3 Timing Chart

This section of the service manual describes the timing that the computer industry recognizes as standard for computer-generated video signals.

Table 2-1. Timing Chart

Mode Timing	IBM		VESA								
	VGA2/ 70 Hz 720 x 400	VGA3/ 60 Hz 640 x 480	640/75 Hz 640 x 480	640/85 Hz 640 x 480	800/75 Hz 800 x 600	800/85 Hz 800 x 600	1024/60Hz 1024 x 768	1024/75Hz 1024 x 768	1024/85Hz 1024x768	1280/76Hz 1280x1024 (Analog Only)	1280/75Hz 1280x1024 (Analog Only)
fH (kHz)	31.469	31.469	37.500	43.269	46.875	53.674	48.363	60.023	68.677	81.129	79.976
A μsec	31.777	31.778	26.667	23.111	21.333	18.631	20.677	16.660	14.561	16.640	12.504
B μsec	3.813	3.813	2.032	1.556	1.616	1.138	2.092	1.219	1.016	6.400	1.067
C μsec	1.589	1.589	3.810	2.222	3.232	2.702	2.462	2.235	2.201	2.880	1.837
D μsec	26.058	26.058	20.317	17.778	16.162	14.222	15.754	13.003	10.836		9.481
E μsec	0.318	0.318	0.508	1.556	0.323	0.569	0.369	0.203	0.508	3.200	0.119
fV (Hz)	70.087	59.940	75.000	85.008	75.000	85.061	60.004	75.029	84.997	76.106	75.025
O msec	14.268	16.683	13.333	11.764	13.333	11.756	16.666	13.328	11.765	10.660	13.329
P msec	0.064	0.064	0.080	0.671	0.064	0.056	0.124	0.050	0.044	0.080	0.038
Q msec	0.858	0.794	0.427	0.578	0.448	0.503	0.600	0.466	0.524	3.200	0.475
R msec	13.155	15.761	12.800	11.093	12.800	11.179	15.880	12.795	11.183		12.804
S msec	0.191	0.064	0.027	0.023	0.021	0.019	0.062	0.017	0.015	0.020	0.013
Clock Freq. (MHz)	28.322	25.175	31.500	49.500	49.500	56.250	75.000	78.750	94.500	135.000	135.000
Polarity H.Sync	Negative	Negative	Negative	Negative	Positive	Positive	Negative	Positive	Positive	Negative	Positive
V.Sync	Positive	Negative	Negative	Negative	Positive	Positive	Negative	Positive	Positive	Negative	Positive
Remark	Separate	Separate	Separate	Separate	Separate	Separate	Separate	Separate	Separate	Com.	Separate

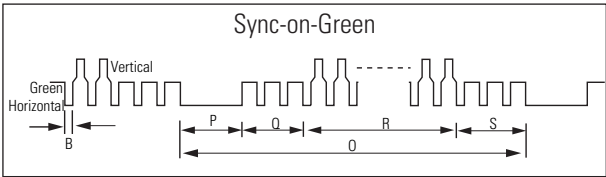
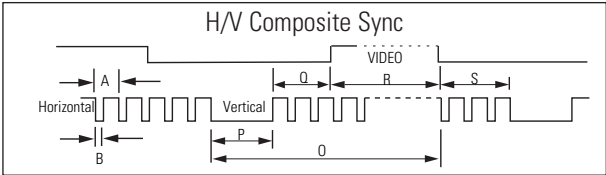
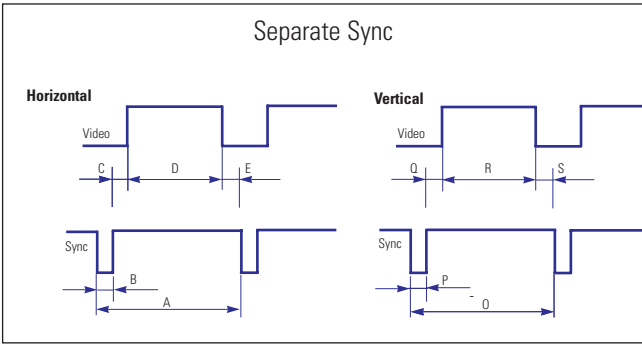

A : Line time total	B : Horizontal sync width	O : Frame time total	P : Vertical sync width
C : Back porch	D : Active time	Q : Back porch	R : Active time
E : Front porch		S : Front porch	

Memo

3 Disassembly and Reassembly

This section of the service manual describes the disassembly and reassembly procedures for the GH17LS/GH17ES TFT-LCD monitors.

WARNING: This monitor contains electrostatically sensitive devices. Use caution when handling these components.

3-1 Disassembly

- Cautions:**
1. Disconnect the monitor from the power source before disassembly.
 2. Follow these directions carefully; never use metal instruments to pry apart the cabinet.

3-1-1 Removing the Stand

1. With a pad beneath it, stand the monitor on its front with the screen facing downward and the base close to you. Make sure nothing will damage the screen.
2. Remove the 4 screws on the Stand.

Caution: Be careful. The signal cable and power cable are still attached to the monitor.

3. Disconnect the Signal Cable and Power Cord.

3-1-2 Main Body Disassembly

1. Remove 2 screws on the Rear Cover.
2. Pull the Rear Cover up and off the monitor.
3. Remove 7 screws on the PCB Shield.
4. Disconnect the Function PCB wire (10P) between the Function PCB and the CN103 connector on the Main PCB.

5. Disconnect 4 Inverter wires between the Panel and the CN2, 3, 4, 5 connectors on the Inverter PCB.
6. Disconnect the interface wire (30P) between the Panel and the CN102 connector on the Main PCB.
7. Remove 3 screws on the Main PCB and 2 screws on the Inverter PCB and 2 screws on the Power Adapter PCB.
8. Disconnect the 12P harness between CN1 connector on the inverter and CN104 connector on the Main PCB.
9. Carefully lift the Main PCB Assembly and Inverter PCB and place them on a flat, level surface that is protected from static electricity.
10. Remove 4 screws on the Bracket Guide. (GH17LS only)
11. Remove 3 screws on the Function PCB from the Front Cover and remove the Function PCB and Function Knob.

3-2 Reassembly

Reassembly procedures are in the reverse order of Disassembly procedures.

4 Alignments and Adjustments

This section of the service manual explains how to use the RS232 JIG.
This function is needed when AD Board Change and program memory (IC110) change.

4-1 Required Equipment

The following equipment is necessary for adjusting the monitor:

- Computer with Windows 95[®], Windows 98[®], or Windows NT[®].
- RS232 JIG.

4-2 RS232 Jig Setup

1. Install Hyper Terminal program from windows system.
2. Configure Baud rate to 19200, select appropriate COM port.
3. Make the Hardware setup as per figure shown.

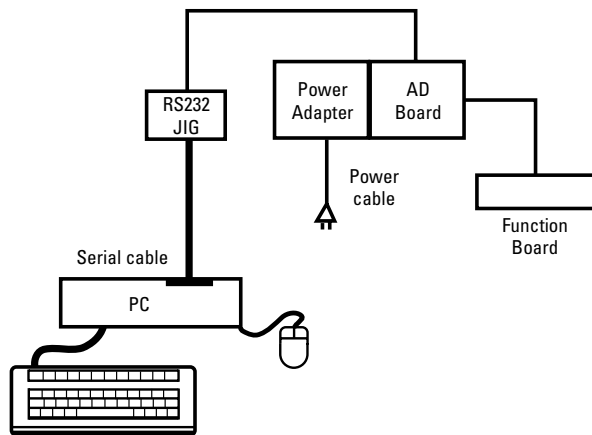

Figure 4-1.

4. Establish the connection by selecting "Connect" from hyper Terminal.
5. Power on the board, now you see messages in the application window.
If no messages than check for 1, 2 and 3 again.

Message :

Gogh 17*** fw. copyright (c) 2000, 2001 Sage.

Date : ***. **. **.

Chip ID : b1.

Panel : Samsung 17 SXGA.

4-3 Changing Board

Before replacing the AD Board, read all Panel information data by using RS232 JIG and hyper terminal.

1. Type character `B`.

Service Menu for Gogh 17 Model.

1. Read.
2. Modify upper Back Light Value.
3. Modify Lower back Light Value.
4. Modify Panel On Time Value.
5. Exit Service Menu

Enter 1

Upper Backlight Time Expired (in hours) : ***

Lower Backlight Time Expired (in hours) : ***

Panel On Time (in hours) : ***

Please note down these values. Than change to new board. Execute the command `B`, read the values. You will see these are set to default values. Change the values to the recorded values. Exit the service menu by `B` command.

2. Color Auto Adjustment

After function `1`. Assemble the monitor.

And display 16-Gray pattern or black and white mixed pattern. Then push "Exit", "-" and "+" key of function same time.

During normal execution of Auto Algorithm the screen image may changed.

4-4 Program memory (IC110) change

Follow same method as changing Board (4-3).

Memo

5 Troubleshooting

- Notes:**
- Before troubleshooting, setup the PC's display as below.
 - Resolution: 1280 x 1024
 - H-frequency: 64 kHz
 - V-frequency: 60 Hz
 - If no picture appears, make sure the power cord is correctly connected.
 - If you push and hold the EXIT button for more than 5 seconds, the monitor automatically turns back to the factory preset.

5-1-1 No Power

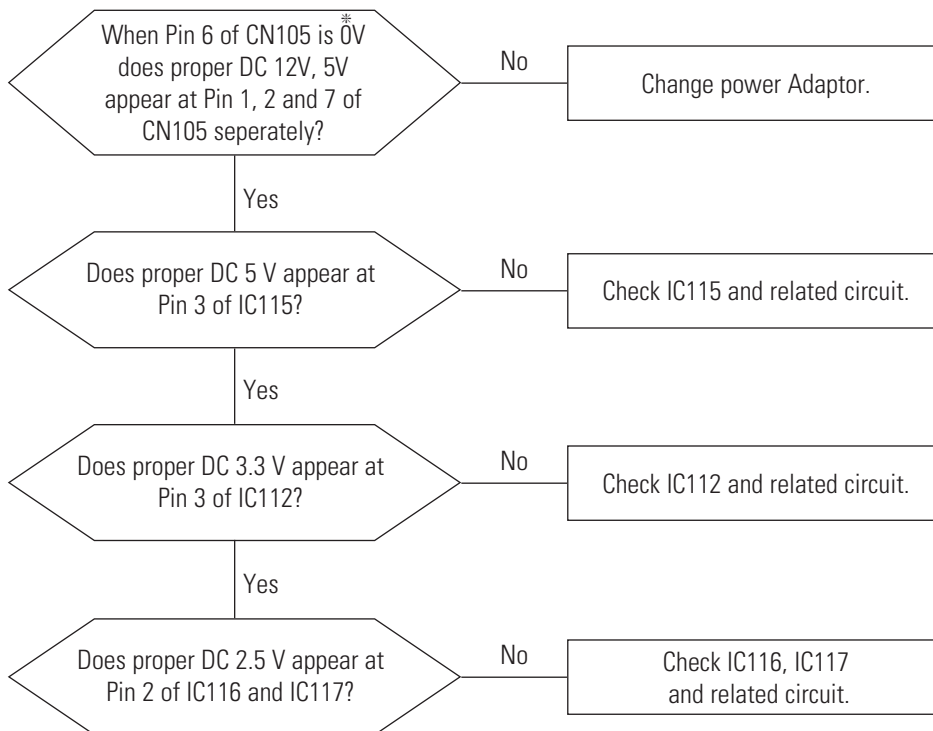

* 0V means power on state.

5-1-2 No Power

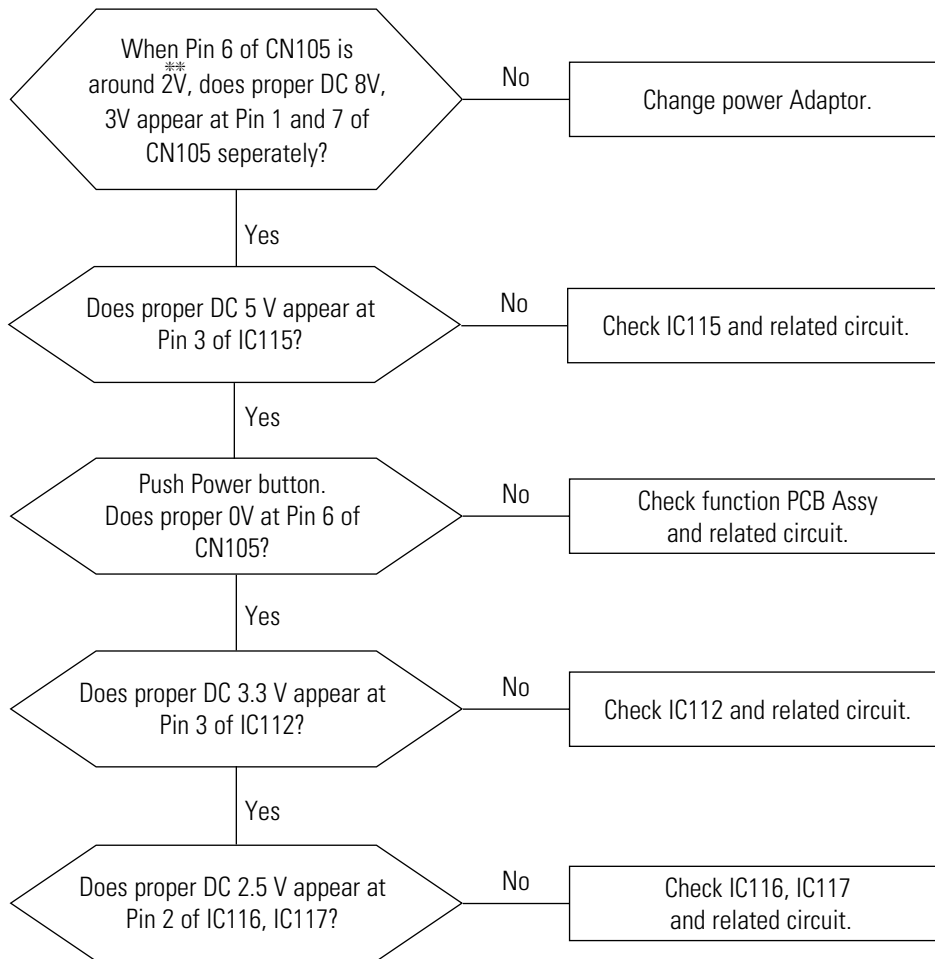

※※ 2V means soft power off or DPMS state.

5-2 No Video

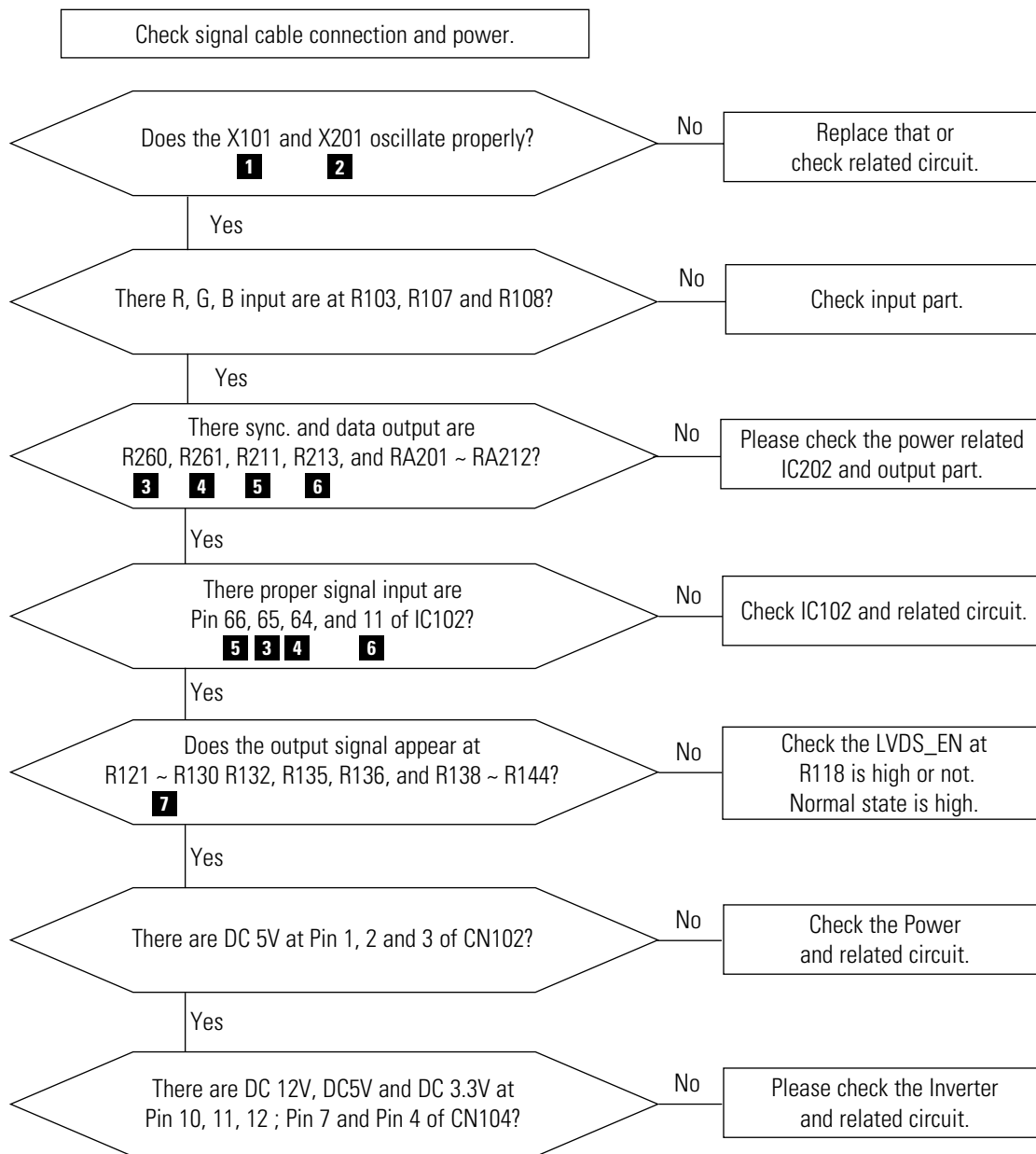

WAVEFORMS

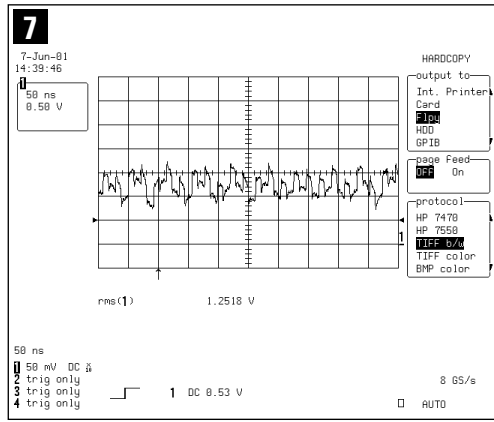
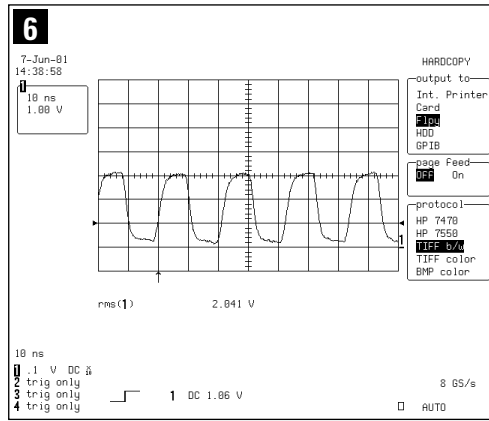
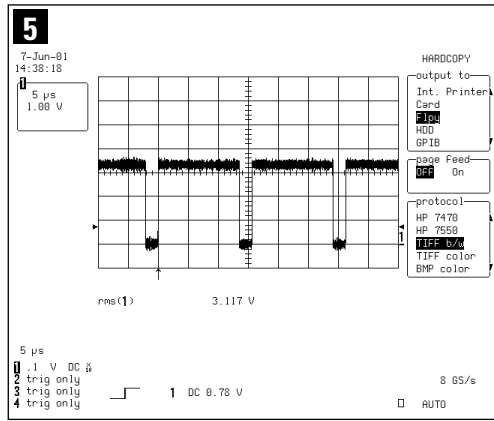
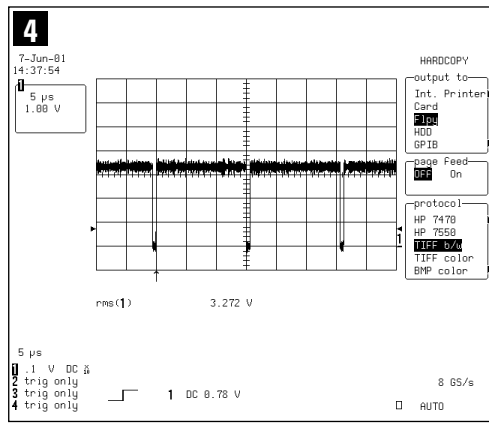
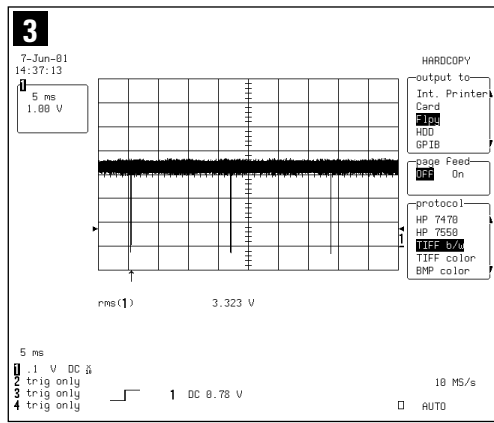
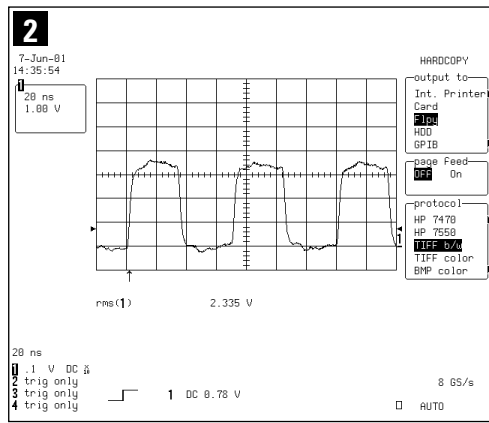
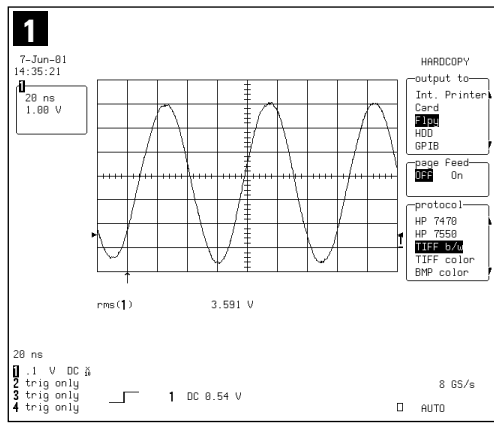

6 Exploded View and Parts List

6-1 GH17LS

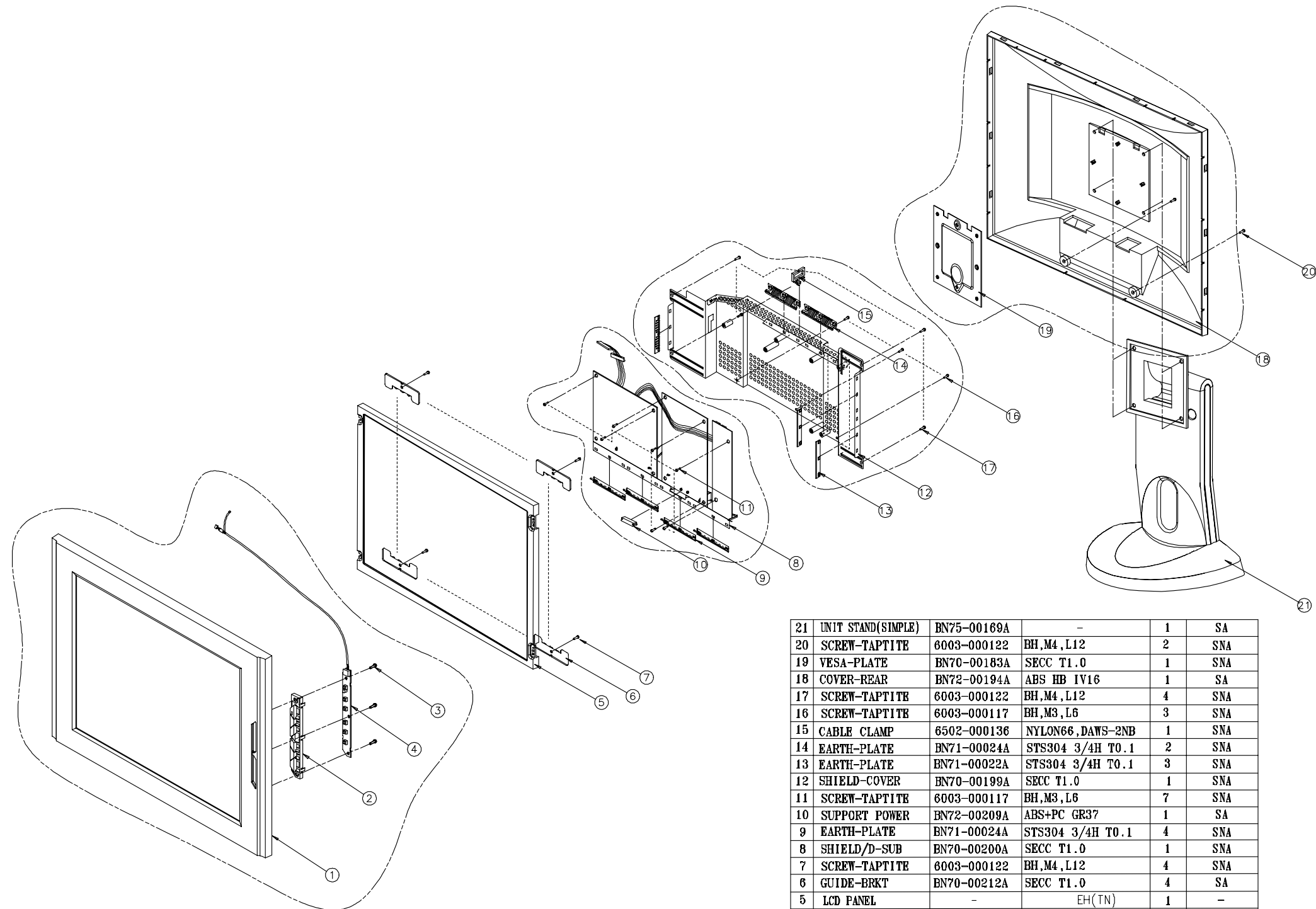

21	UNIT STAND(SIMPLE)	BN75-00169A	-	1	SA
20	SCREW-TAPTITE	6003-000122	BH,M4,L12	2	SNA
19	VESA-PLATE	BN70-00183A	SECC T1.0	1	SNA
18	COVER-REAR	BN72-00194A	ABS HB IV16	1	SA
17	SCREW-TAPTITE	6003-000122	BH,M4,L12	4	SNA
16	SCREW-TAPTITE	6003-000117	BH,M3,L6	3	SNA
15	CABLE CLAMP	6502-000136	NYLON66,DAWS-2NB	1	SNA
14	EARTH-PLATE	BN71-00024A	STS304 3/4H T0.1	2	SNA
13	EARTH-PLATE	BN71-00022A	STS304 3/4H T0.1	3	SNA
12	SHIELD-COVER	BN70-00199A	SECC T1.0	1	SNA
11	SCREW-TAPTITE	6003-000117	BH,M3,L6	7	SNA
10	SUPPORT POWER	BN72-00209A	ABS+PC GR37	1	SA
9	EARTH-PLATE	BN71-00024A	STS304 3/4H T0.1	4	SNA
8	SHIELD/D-SUB	BN70-00200A	SECC T1.0	1	SNA
7	SCREW-TAPTITE	6003-000122	BH,M4,L12	4	SNA
6	GUIDE-BRKT	BN70-00212A	SECC T1.0	4	SA
5	LCD PANEL	-	EH(TN)	1	-
4	FUNCTION PCB	-	-	1	-
3	SCREW-TAPTITE	6003-000010	BWH M3 L10	3	SNA
2	KNOB-FUNCTION	BN64-00027A	ABS+PC 5V IV16	1	SA
1	COVER-FRONT	BN72-00193A	ABS HB IV16	1	SNA
NO	PART NAME	CODE NO.	SPEC.	Q'TY	REMARK
UNIT PART LIST					

6-2 GH17ES

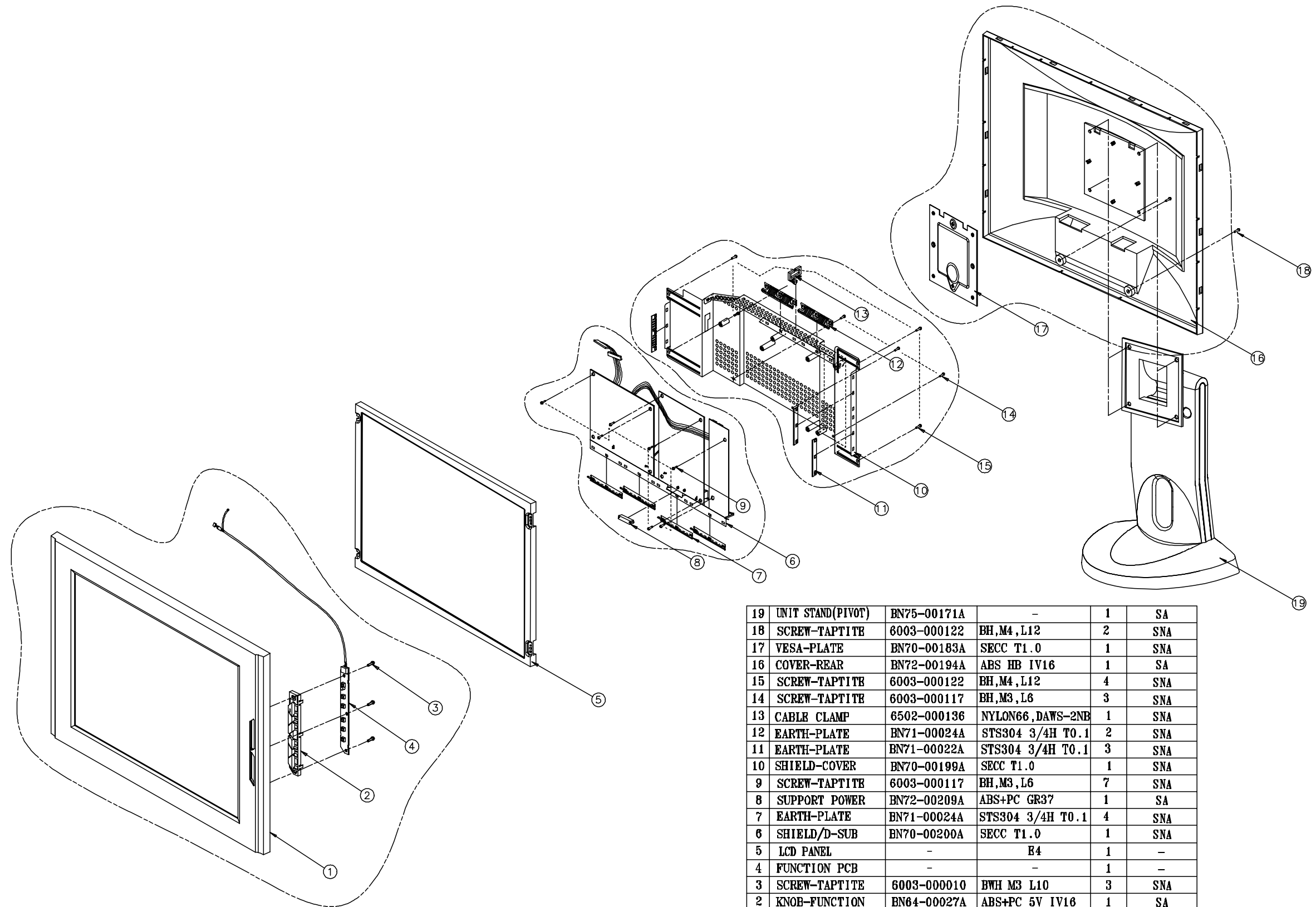

19	UNIT STAND(PIVOT)	BN75-00171A	-	1	SA
18	SCREW-TAPTITE	6003-000122	BH,M4,L12	2	SNA
17	VESA-PLATE	BN70-00183A	SECC T1.0	1	SNA
16	COVER-REAR	BN72-00194A	ABS HB IV16	1	SA
15	SCREW-TAPTITE	6003-000122	BH,M4,L12	4	SNA
14	SCREW-TAPTITE	6003-000117	BH,M3,L6	3	SNA
13	CABLE CLAMP	6502-000136	NYLON66,DAWS-2NB	1	SNA
12	EARTH-PLATE	BN71-00024A	STS304 3/4H T0.1	2	SNA
11	EARTH-PLATE	BN71-00022A	STS304 3/4H T0.1	3	SNA
10	SHIELD-COVER	BN70-00199A	SECC T1.0	1	SNA
9	SCREW-TAPTITE	6003-000117	BH,M3,L6	7	SNA
8	SUPPORT POWER	BN72-00209A	ABS+PC GR37	1	SA
7	EARTH-PLATE	BN71-00024A	STS304 3/4H T0.1	4	SNA
6	SHIELD/D-SUB	BN70-00200A	SECC T1.0	1	SNA
5	LCD PANEL	-	R4	1	-
4	FUNCTION PCB	-	-	1	-
3	SCREW-TAPTITE	6003-000010	BWH M3 L10	3	SNA
2	KNOB-FUNCTION	BN64-00027A	ABS+PC 5V IV16	1	SA
1	COVER-FRONT	BN72-00193A	ABS HB IV16	1	SNA
NO	PART NAME	CODE NO.	SPEC.	Q'TY	REMARK
UNIT PART LIST					

7 Electrical Parts List

7-1 Main PCB Parts

Loc. No.	Code No.	Description	Specification	Remarks
CIS	0201-001223	ADHESIVE-TS	HT-130S,RED,700+/- 50,-	SNA
CIS	0202-001044	SOLDER-WIRE.	S63S-W3.0,S63S,D3,63Sn/37Pb,-	SNA
CIS	0202-001046	SOLDER-WIRE FLUX	CF-110VH-2A,-,-,-	SNA
CIS	0202-001162	SOLDER-CREAM	RMA-20-21L,S63,-,SN63/PB36.6/AGO.4,FLUX9.5%	SNA
CIS	0202-001172	SOLDER-WIRE FLUX	RS-107,RS60,D1.2,SN60/PB40,-	SNA
CIS	0204-001095	THINNER	#4520,-,-,-	SNA
CIS	BN44-00054A	ADAPTOR	DPA34L,170S,100-240VAC,47-63HZ,12V/5V,2A/2A,-,34W,AC-DC,-,10-+40C,-,-	
CIS	BN72-00209A	SUPPORT-POWER	GH15LS,ABS+PC,GR37,-,5V,-,-,-	SNA
CIS	BN75-00177A	UNIT-SHIELD/DSUB	GH17LS,-,SPT E T0.5,-,-,-,-	SNA
CIS	BN46-00008H	MICOM-S/W,GOGH	GH17LS,-,-,-,-,-	SNA
CN101	3701-001219	CONNECTOR-DSUB	15P,3R,FEMALE,ANGLE,AUF	
CN105	3711-004853	CONNECTOR-HEADER	BOX,7P,1R,2MM,ANGLE,SN,WHT	SNA
CN106	3711-000056	CONNECTOR-HEADER	BOX,2P,1R,2.5mm,ANGLE,SN	SNA
CN108	3711-001465	CONNECTOR-HEADER	NOWALL,3P,1R,2.54mm,STRAIGHT,A	SNA
IC110	1102-001097	IC-EPROM	270010,128KX8BIT,PLCC,32P,-,90NS,5V,10%,PLASTIC,0T0+70C,0.1MA,CMOS,TR	
BD101	3301-001145	CORE-FERRITE BEAD	AB,4.5x1.6x1.6mm,-,-	SNA
BD104	3301-001145	CORE-FERRITE BEAD	AB,4.5x1.6x1.6mm,-,-	SNA
BD105	3301-001145	CORE-FERRITE BEAD	AB,4.5x1.6x1.6mm,-,-	SNA
BD106	3301-001163	CORE-FERRITE BEAD	AB,80ohm,2x1.25x1mm,300mA,TP,FERRITE,0.08ohm	SNA
BD107	3301-001163	CORE-FERRITE BEAD	AB,80ohm,2x1.25x1mm,300mA,TP,FERRITE,0.08ohm	SNA
BD108	3301-001163	CORE-FERRITE BEAD	AB,80ohm,2x1.25x1mm,300mA,TP,FERRITE,0.08ohm	SNA
C101	2203-005005	C-CERAMIC,CHIP	100nF,10%,16V,X7R,TP,1608	
C102	2203-005005	C-CERAMIC,CHIP	100nF,10%,16V,X7R,TP,1608	
C103	2203-005005	C-CERAMIC,CHIP	100nF,10%,16V,X7R,TP,1608	
C104	2203-005005	C-CERAMIC,CHIP	100nF,10%,16V,X7R,TP,1608	
C105	2203-005005	C-CERAMIC,CHIP	100nF,10%,16V,X7R,TP,1608	
C106	2203-005005	C-CERAMIC,CHIP	100nF,10%,16V,X7R,TP,1608	
C107	2402-000176	C-AL,SMD	10uF,20%,16V,GP,TP,4.3x4.3x5.4	
C111	2402-000176	C-AL,SMD	10uF,20%,16V,GP,TP,4.3x4.3x5.4	
C112	2203-005005	C-CERAMIC,CHIP	100nF,10%,16V,X7R,TP,1608	
C113	2203-005005	C-CERAMIC,CHIP	100nF,10%,16V,X7R,TP,1608	
C114	2203-005005	C-CERAMIC,CHIP	100nF,10%,16V,X7R,TP,1608	
C115	2402-000176	C-AL,SMD	10uF,20%,16V,GP,TP,4.3x4.3x5.4	
C116	2203-005005	C-CERAMIC,CHIP	100nF,10%,16V,X7R,TP,1608	
C117	2203-005005	C-CERAMIC,CHIP	100nF,10%,16V,X7R,TP,1608	
C118	2203-005005	C-CERAMIC,CHIP	100nF,10%,16V,X7R,TP,1608	
C121	2203-000257	C-CERAMIC,CHIP	10nF,10%,50V,X7R,TP,1608	
C122	2402-000176	C-AL,SMD	10uF,20%,16V,GP,TP,4.3x4.3x5.4	
C123	2203-000257	C-CERAMIC,CHIP	10nF,10%,50V,X7R,TP,1608	
C124	2402-000176	C-AL,SMD	10uF,20%,16V,GP,TP,4.3x4.3x5.4	
C125	2203-005005	C-CERAMIC,CHIP	100nF,10%,16V,X7R,TP,1608	
C126	2402-001042	C-AL,SMD	100uF,20%,16V,GP,TP,6.6x6.6x5.4mm	
C127	2203-005005	C-CERAMIC,CHIP	100nF,10%,16V,X7R,TP,1608	
C128	2203-005005	C-CERAMIC,CHIP	100nF,10%,16V,X7R,TP,1608	
C129	2203-005005	C-CERAMIC,CHIP	100nF,10%,16V,X7R,TP,1608	
C130	2203-000257	C-CERAMIC,CHIP	10nF,10%,50V,X7R,TP,1608	
C131	2402-000176	C-AL,SMD	10uF,20%,16V,GP,TP,4.3x4.3x5.4	
C132	2402-000176	C-AL,SMD	10uF,20%,16V,GP,TP,4.3x4.3x5.4	

7 Electrical Parts List

Loc. No.	Code No.	Description	Specification	Remarks
C136	2203-000626	C-CERAMIC,CHIP	0.022nF,5%,50V,NP0,TP,1608	
C143	2203-000257	C-CERAMIC,CHIP	10nF,10%,50V,X7R,TP,1608	
C144	2402-001044	C-AL,SMD	100uF,20%,25V,-,TP,8.3x8.3x6.3	
C145	2203-005005	C-CERAMIC,CHIP	100nF,10%,16V,X7R,TP,1608	
C146	2203-005005	C-CERAMIC,CHIP	100nF,10%,16V,X7R,TP,1608	
C147	2203-000257	C-CERAMIC,CHIP	10nF,10%,50V,X7R,TP,1608	
C148	2203-000257	C-CERAMIC,CHIP	10nF,10%,50V,X7R,TP,1608	
C149	2203-000257	C-CERAMIC,CHIP	10nF,10%,50V,X7R,TP,1608	
C150	2203-000257	C-CERAMIC,CHIP	10nF,10%,50V,X7R,TP,1608	
C151	2203-000257	C-CERAMIC,CHIP	10nF,10%,50V,X7R,TP,1608	
C152	2203-000257	C-CERAMIC,CHIP	10nF,10%,50V,X7R,TP,1608	
C153	2203-000626	C-CERAMIC,CHIP	0.022nF,5%,50V,NP0,TP,1608	
C162	2203-005533	C-CERAMIC,CHIP	1000nF,20%,6.3V,X7R,TP,1608	
C163	2203-005533	C-CERAMIC,CHIP	1000nF,20%,6.3V,X7R,TP,1608	
C164	2203-005533	C-CERAMIC,CHIP	1000nF,20%,6.3V,X7R,TP,1608	
C165	2203-005005	C-CERAMIC,CHIP	100nF,10%,16V,X7R,TP,1608	
C166	2402-000144	C-AL,SMD	3.3uF,20%,50V,GP,TP,4.3x4.3x5.	
C168	2402-000176	C-AL,SMD	10uF,20%,16V,GP,TP,4.3x4.3x5.4	
C169	2203-005005	C-CERAMIC,CHIP	100nF,10%,16V,X7R,TP,1608	
C170	2203-005005	C-CERAMIC,CHIP	100nF,10%,16V,X7R,TP,1608	
C171	2402-000179	C-AL,SMD	47uF,20%,16V,GP,TP,6.6x6.6x5.4	
C172	2402-000179	C-AL,SMD	47uF,20%,16V,GP,TP,6.6x6.6x5.4	
C173	2203-005005	C-CERAMIC,CHIP	100nF,10%,16V,X7R,TP,1608	
C174	2203-005005	C-CERAMIC,CHIP	100nF,10%,16V,X7R,TP,1608	
C175	2409-001029	C-ORGANIC	120uF,20%,6.3V,WT,TP,10.3x10.3x10.3mm,9	
C176	2402-000179	C-AL,SMD	47uF,20%,16V,GP,TP,6.6x6.6x5.4	
C177	2203-005005	C-CERAMIC,CHIP	100nF,10%,16V,X7R,TP,1608	
C178	2203-005005	C-CERAMIC,CHIP	100nF,10%,16V,X7R,TP,1608	
C179	2402-000176	C-AL,SMD	10uF,20%,16V,GP,TP,4.3x4.3x5.4	
C180	2203-005005	C-CERAMIC,CHIP	100nF,10%,16V,X7R,TP,1608	
C181	2402-000179	C-AL,SMD	47uF,20%,16V,GP,TP,6.6x6.6x5.4	
C182	2203-005005	C-CERAMIC,CHIP	100nF,10%,16V,X7R,TP,1608	
C183	2203-000236	C-CERAMIC,CHIP	0.1nF,5%,50V,NP0,TP,1608	
C184	2203-005005	C-CERAMIC,CHIP	100nF,10%,16V,X7R,TP,1608	
C185	2402-000176	C-AL,SMD	10uF,20%,16V,GP,TP,4.3x4.3x5.4	
C187	2203-005005	C-CERAMIC,CHIP	100nF,10%,16V,X7R,TP,1608	
C188	2203-000697	C-CERAMIC,CHIP	0.002nF,0.25pF,50V,NP0,TP,1608	
C189	2203-000697	C-CERAMIC,CHIP	0.002nF,0.25pF,50V,NP0,TP,1608	
C190	2203-000697	C-CERAMIC,CHIP	0.002nF,0.25pF,50V,NP0,TP,1608	
C191	2203-005005	C-CERAMIC,CHIP	100nF,10%,16V,X7R,TP,1608	
C192	2402-001044	C-AL,SMD	100uF,20%,25V,-,TP,8.3x8.3x6.3	
C193	2402-000176	C-AL,SMD	10uF,20%,16V,GP,TP,4.3x4.3x5.4	
C194	2402-000179	C-AL,SMD	47uF,20%,16V,GP,TP,6.6x6.6x5.4	
C201	2203-005005	C-CERAMIC,CHIP	100nF,10%,16V,X7R,TP,1608	
C202	2402-000176	C-AL,SMD	10uF,20%,16V,GP,TP,4.3x4.3x5.4	
C207	2203-005005	C-CERAMIC,CHIP	100nF,10%,16V,X7R,TP,1608	
C208	2402-000176	C-AL,SMD	10uF,20%,16V,GP,TP,4.3x4.3x5.4	
C209	2203-005005	C-CERAMIC,CHIP	100nF,10%,16V,X7R,TP,1608	
C210	2402-000176	C-AL,SMD	10uF,20%,16V,GP,TP,4.3x4.3x5.4	
C211	2203-005005	C-CERAMIC,CHIP	100nF,10%,16V,X7R,TP,1608	
C212	2402-000176	C-AL,SMD	10uF,20%,16V,GP,TP,4.3x4.3x5.4	

Loc. No.	Code No.	Description	Specification	Remarks
C213	2203-005005	C-CERAMIC,CHIP	100nF,10%,16V,X7R,TP,1608	
C214	2402-000176	C-AL,SMD	10uF,20%,16V,GP,TP,4.3x4.3x5.4	
C216	2402-000176	C-AL,SMD	10uF,20%,16V,GP,TP,4.3x4.3x5.4	
C218	2402-000176	C-AL,SMD	10uF,20%,16V,GP,TP,4.3x4.3x5.4	
C219	2203-005005	C-CERAMIC,CHIP	100nF,10%,16V,X7R,TP,1608	
C220	2402-000176	C-AL,SMD	10uF,20%,16V,GP,TP,4.3x4.3x5.4	
C221	2402-000176	C-AL,SMD	10uF,20%,16V,GP,TP,4.3x4.3x5.4	
C222	2203-005005	C-CERAMIC,CHIP	100nF,10%,16V,X7R,TP,1608	
C223	2203-005005	C-CERAMIC,CHIP	100nF,10%,16V,X7R,TP,1608	
C224	2203-005005	C-CERAMIC,CHIP	100nF,10%,16V,X7R,TP,1608	
C225	2203-005005	C-CERAMIC,CHIP	100nF,10%,16V,X7R,TP,1608	
C226	2203-005005	C-CERAMIC,CHIP	100nF,10%,16V,X7R,TP,1608	
C227	2203-005005	C-CERAMIC,CHIP	100nF,10%,16V,X7R,TP,1608	
C228	2203-005005	C-CERAMIC,CHIP	100nF,10%,16V,X7R,TP,1608	
C229	2203-005005	C-CERAMIC,CHIP	100nF,10%,16V,X7R,TP,1608	
C230	2203-005005	C-CERAMIC,CHIP	100nF,10%,16V,X7R,TP,1608	
C231	2203-005005	C-CERAMIC,CHIP	100nF,10%,16V,X7R,TP,1608	
C236	2203-005005	C-CERAMIC,CHIP	100nF,10%,16V,X7R,TP,1608	
C237	2203-005005	C-CERAMIC,CHIP	100nF,10%,16V,X7R,TP,1608	
C238	2203-005005	C-CERAMIC,CHIP	100nF,10%,16V,X7R,TP,1608	
C239	2203-005005	C-CERAMIC,CHIP	100nF,10%,16V,X7R,TP,1608	
C240	2203-005005	C-CERAMIC,CHIP	100nF,10%,16V,X7R,TP,1608	
C241	2203-005005	C-CERAMIC,CHIP	100nF,10%,16V,X7R,TP,1608	
C242	2203-005005	C-CERAMIC,CHIP	100nF,10%,16V,X7R,TP,1608	
C243	2203-005005	C-CERAMIC,CHIP	100nF,10%,16V,X7R,TP,1608	
C244	2203-000440	C-CERAMIC,CHIP	1nF,10%,50V,X7R,TP,1608,-	
C245	2203-005005	C-CERAMIC,CHIP	100nF,10%,16V,X7R,TP,1608	
C246	2203-005005	C-CERAMIC,CHIP	100nF,10%,16V,X7R,TP,1608	
C247	2402-000176	C-AL,SMD	10uF,20%,16V,GP,TP,4.3x4.3x5.4	
C248	2203-000440	C-CERAMIC,CHIP	1nF,10%,50V,X7R,TP,1608,-	
C249	2203-005005	C-CERAMIC,CHIP	100nF,10%,16V,X7R,TP,1608	
C250	2203-005005	C-CERAMIC,CHIP	100nF,10%,16V,X7R,TP,1608	
C251	2203-005005	C-CERAMIC,CHIP	100nF,10%,16V,X7R,TP,1608	
C252	2203-005005	C-CERAMIC,CHIP	100nF,10%,16V,X7R,TP,1608	
C253	2203-000440	C-CERAMIC,CHIP	1nF,10%,50V,X7R,TP,1608,-	
C254	2203-000440	C-CERAMIC,CHIP	1nF,10%,50V,X7R,TP,1608,-	
C255	2402-000176	C-AL,SMD	10uF,20%,16V,GP,TP,4.3x4.3x5.4	
C256	2203-000440	C-CERAMIC,CHIP	1nF,10%,50V,X7R,TP,1608,-	
C257	2402-001006	C-AL,SMD	4.7uF,20%,25V,GP,TP,3.6x6.3x3.	
C258	2203-000440	C-CERAMIC,CHIP	1nF,10%,50V,X7R,TP,1608,-	
C259	2203-005005	C-CERAMIC,CHIP	100nF,10%,16V,X7R,TP,1608	
C260	2402-000176	C-AL,SMD	10uF,20%,16V,GP,TP,4.3x4.3x5.4	
C264	2203-005005	C-CERAMIC,CHIP	100nF,10%,16V,X7R,TP,1608	
C265	2402-001006	C-AL,SMD	4.7uF,20%,25V,GP,TP,3.6x6.3x3.	
C267	2203-005005	C-CERAMIC,CHIP	100nF,10%,16V,X7R,TP,1608	
C268	2402-000176	C-AL,SMD	10uF,20%,16V,GP,TP,4.3x4.3x5.4	
C269	2203-005005	C-CERAMIC,CHIP	100nF,10%,16V,X7R,TP,1608	
C270	2203-005005	C-CERAMIC,CHIP	100nF,10%,16V,X7R,TP,1608	
C271	2203-005005	C-CERAMIC,CHIP	100nF,10%,16V,X7R,TP,1608	
C272	2409-001029	C-ORGANIC	120uF,20%,6.3V,WT,TP,10.3x10.3x10.3mm,9	
CN102	3711-004070	CONNECTOR-HEADER	BOX,30P,1R,1.25mm,SMD-A,SN	SNA

Loc. No.	Code No.	Description	Specification	Remarks
CN103	3711-002050	CONNECTOR-HEADER	BOX,10P,1R,1.25mm,SMD-A,SN	SNA
CN104	3711-000556	CONNECTOR-HEADER	BOX,12P,1R,1.25mm,SMD-A,SN	SNA
CN107	3711-002049	CONNECTOR-HEADER	BOX,6P,1R,1.25mm,SMD-A,SN	SNA
D101	0401-001056	DIODE-SWITCHING	MMBD4148SE,75V,200MA,SOT-23,TP	
D102	0401-001056	DIODE-SWITCHING	MMBD4148SE,75V,200MA,SOT-23,TP	
D103	0401-001056	DIODE-SWITCHING	MMBD4148SE,75V,200MA,SOT-23,TP	
D104	0401-001056	DIODE-SWITCHING	MMBD4148SE,75V,200MA,SOT-23,TP	
D105	0401-001056	DIODE-SWITCHING	MMBD4148SE,75V,200MA,SOT-23,TP	
D106	0401-001056	DIODE-SWITCHING	MMBD4148SE,75V,200MA,SOT-23,TP	
D107	0402-000553	DIODE-RECTIFIER	SS24,40V,2.0A,DO-214AA	
FT101	2901-001114	FILTER-EMI SMD	25VDC,2.0ADC,-,100nF,3.2x1.6x1	
FT102	2901-001114	FILTER-EMI SMD	25VDC,2.0ADC,-,100nF,3.2x1.6x1	
FT103	2901-001114	FILTER-EMI SMD	25VDC,2.0ADC,-,100nF,3.2x1.6x1	
FT104	2901-001114	FILTER-EMI SMD	25VDC,2.0ADC,-,100nF,3.2x1.6x1	
FT105	2901-001114	FILTER-EMI SMD	25VDC,2.0ADC,-,100nF,3.2x1.6x1	
FT106	2901-001114	FILTER-EMI SMD	25VDC,2.0ADC,-,100nF,3.2x1.6x1	
FT109	3301-001145	CORE-FERRITE BEAD	AB,4.5x1.6x1.6mm,-,-	SNA
FT110	3301-001145	CORE-FERRITE BEAD	AB,4.5x1.6x1.6mm,-,-	SNA
FT112	3301-001145	CORE-FERRITE BEAD	AB,4.5x1.6x1.6mm,-,-	SNA
FT113	3301-001145	CORE-FERRITE BEAD	AB,4.5x1.6x1.6mm,-,-	SNA
FT201	3301-001145	CORE-FERRITE BEAD	AB,4.5x1.6x1.6mm,-,-	SNA
FT202	3301-001145	CORE-FERRITE BEAD	AB,4.5x1.6x1.6mm,-,-	SNA
FT203	3301-001145	CORE-FERRITE BEAD	AB,4.5x1.6x1.6mm,-,-	SNA
FT204	3301-001145	CORE-FERRITE BEAD	AB,4.5x1.6x1.6mm,-,-	SNA
FT205	3301-001145	CORE-FERRITE BEAD	AB,4.5x1.6x1.6mm,-,-	SNA
IC101	1103-001164	IC-EEPROM	24LC21A,128X8BIT,SOP,8P,150MIL,-5V,10%,PLASTIC,0 TO +70C,100UA,CMOS,TP	
IC102	1205-001870	IC-TRANSMITTER	DS90C387VJD,QFP,100P,550MIL,PLASTIC,3.6V,2.8W,-10to+70C,TR,Dual Pixel LVDS	
IC103	1103-000138	IC-EEPROM	24C16,2Kx8BIT,SOP,8P,150MIL,10	
IC104	0803-000106	IC-TTL	74F132,TRIGGER,SOP,14P,150MIL,	
IC105	1203-001109	IC-VOL. DETECTOR	7045,SOT-89,3P,-,PLASTIC,4.3/4	
IC106	0903-001215	IC-MICROCONTROLLER	80C32X2,8Bit,PLCC,44P,-,40MHz,TR,CMOS,PLASTIC,5V,1W,0to+70C,256BYTE,-,8Bit,300nS	SNA
IC107	0505-001170	FET-SILICON	SI9933ADY-T1,P,-,20V,3.4A,0.06ohm,2W,SO-8	
IC109	0802-001108	IC-BICMOS LOGIC	74ABT573,LATCH,TSSOP,20P,173MIL,8,TR,PLASTIC,3-STATE,-,0.55V,-65TO+150C,-,0.8V,5	
IC110_SOCKET	3704-000249	SOCKET-IC	32P,PLCC,SN,1.27mm	
IC112	1203-001293	IC-POSI.FIXED REG.	033,TO-252,3P,6.5MIL,PLASTIC,3	
IC115	1203-001488	IC-POSI.FIXED REG.	7805,TO-252,3P,-,PLASTIC,4.8/5	
IC116	1203-001465	IC-POSI.ADJUST REG.	317,TO-263,3P,-,PLASTIC,1.2/37	
IC117	1203-001465	IC-POSI.ADJUST REG.	317,TO-263,3P,-,PLASTIC,1.2/37	
IC118	0505-001170	FET-SILICON	SI9933ADY-T1,P,-,20V,3.4A,0.06ohm,2W,SO-8	
IC202	1205-002028	IC-LCD CONTROLLER	JAGASM,BGA,388P,208MIL,PLASTIC,3.45V,2.5W,-40TO+125C,TR,DIGITAL DISPLAY PRO.	
L201	2703-001778	INDUCTOR-SMD	3.3UH,20%,3.2X2.5X2.2MM	
L206	2703-001778	INDUCTOR-SMD	3.3UH,20%,3.2X2.5X2.2MM	
L207	2703-001778	INDUCTOR-SMD	3.3UH,20%,3.2X2.5X2.2MM	
MP1.0	BN41-00089A	PCB MAIN	GH17LS,FR4,4L,1.0,1.6,120X110,GH17LS,-,-,-	
Q101	0501-002080	TR-SMALL SIGNAL	2SC2412K,NPN,200mW,SC-59,TP,120-270	
Q103	0501-002080	TR-SMALL SIGNAL	2SC2412K,NPN,200mW,SC-59,TP,120-270	
Q105	0501-002080	TR-SMALL SIGNAL	2SC2412K,NPN,200mW,SC-59,TP,120-270	
Q106	0501-002080	TR-SMALL SIGNAL	2SC2412K,NPN,200mW,SC-59,TP,120-270	
Q107	0501-002080	TR-SMALL SIGNAL	2SC2412K,NPN,200mW,SC-59,TP,120-270	
Q108	0501-002080	TR-SMALL SIGNAL	2SC2412K,NPN,200mW,SC-59,TP,120-270	
Q109	0501-002080	TR-SMALL SIGNAL	2SC2412K,NPN,200mW,SC-59,TP,120-270	

Loc. No.	Code No.	Description	Specification	Remarks
Q110	0501-002080	TR-SMALL SIGNAL	2SC2412K,NPN,200mW,SC-59,TP,120-270	
Q111	0501-002080	TR-SMALL SIGNAL	2SC2412K,NPN,200mW,SC-59,TP,120-270	
Q201	0501-002080	TR-SMALL SIGNAL	2SC2412K,NPN,200mW,SC-59,TP,120-270	
R101	2007-000084	R-CHIP	4.7Kohm,5%,1/16W,DA,TP,1608	
R102	2007-000084	R-CHIP	4.7Kohm,5%,1/16W,DA,TP,1608	
R103	2007-000309	R-CHIP	10ohm,5%,1/16W,DA,TP,1608	
R104	2007-000074	R-CHIP	100ohm,5%,1/16W,DA,TP,1608	
R105	2007-000074	R-CHIP	100ohm,5%,1/16W,DA,TP,1608	
R106	2007-000074	R-CHIP	100ohm,5%,1/16W,DA,TP,1608	
R107	2007-000309	R-CHIP	10ohm,5%,1/16W,DA,TP,1608	
R108	2007-000309	R-CHIP	10ohm,5%,1/16W,DA,TP,1608	
R109	2007-000074	R-CHIP	100ohm,5%,1/16W,DA,TP,1608	
R110	2007-000090	R-CHIP	10KOHM,5%,1/16W,DA,TP,1608	
R111	2007-000090	R-CHIP	10KOHM,5%,1/16W,DA,TP,1608	
R112	2007-001167	R-CHIP	75ohm,5%,1/16W,DA,TP,1608	
R113	2007-001167	R-CHIP	75ohm,5%,1/16W,DA,TP,1608	
R114	2007-001167	R-CHIP	75ohm,5%,1/16W,DA,TP,1608	
R115	2007-000090	R-CHIP	10KOHM,5%,1/16W,DA,TP,1608	
R116	2007-000090	R-CHIP	10KOHM,5%,1/16W,DA,TP,1608	
R117	2007-000090	R-CHIP	10KOHM,5%,1/16W,DA,TP,1608	
R118	2007-000072	R-CHIP	47ohm,5%,1/16W,DA,TP,1608	
R119	2007-000090	R-CHIP	10KOHM,5%,1/16W,DA,TP,1608	
R120	2007-000090	R-CHIP	10KOHM,5%,1/16W,DA,TP,1608	
R121	2007-000072	R-CHIP	47ohm,5%,1/16W,DA,TP,1608	
R122	2007-000072	R-CHIP	47ohm,5%,1/16W,DA,TP,1608	
R123	2007-000072	R-CHIP	47ohm,5%,1/16W,DA,TP,1608	
R124	2007-000072	R-CHIP	47ohm,5%,1/16W,DA,TP,1608	
R125	2007-000072	R-CHIP	47ohm,5%,1/16W,DA,TP,1608	
R126	2007-000072	R-CHIP	47ohm,5%,1/16W,DA,TP,1608	
R127	2007-000072	R-CHIP	47ohm,5%,1/16W,DA,TP,1608	
R128	2007-000072	R-CHIP	47ohm,5%,1/16W,DA,TP,1608	
R129	2007-000072	R-CHIP	47ohm,5%,1/16W,DA,TP,1608	
R130	2007-000072	R-CHIP	47ohm,5%,1/16W,DA,TP,1608	
R131	2007-000074	R-CHIP	100ohm,5%,1/16W,DA,TP,1608	
R132	2007-000072	R-CHIP	47ohm,5%,1/16W,DA,TP,1608	
R133	2007-000084	R-CHIP	4.7Kohm,5%,1/16W,DA,TP,1608	
R134	2007-000084	R-CHIP	4.7Kohm,5%,1/16W,DA,TP,1608	
R135	2007-000072	R-CHIP	47ohm,5%,1/16W,DA,TP,1608	
R136	2007-000072	R-CHIP	47ohm,5%,1/16W,DA,TP,1608	
R137	2007-000074	R-CHIP	100ohm,5%,1/16W,DA,TP,1608	
R138	2007-000072	R-CHIP	47ohm,5%,1/16W,DA,TP,1608	
R139	2007-000072	R-CHIP	47ohm,5%,1/16W,DA,TP,1608	
R140	2007-000072	R-CHIP	47ohm,5%,1/16W,DA,TP,1608	
R141	2007-000072	R-CHIP	47ohm,5%,1/16W,DA,TP,1608	
R142	2007-000072	R-CHIP	47ohm,5%,1/16W,DA,TP,1608	
R143	2007-000072	R-CHIP	47ohm,5%,1/16W,DA,TP,1608	
R144	2007-000072	R-CHIP	47ohm,5%,1/16W,DA,TP,1608	
R145	2007-000074	R-CHIP	100ohm,5%,1/16W,DA,TP,1608	
R146	2007-000074	R-CHIP	100ohm,5%,1/16W,DA,TP,1608	
R147	2007-000074	R-CHIP	100ohm,5%,1/16W,DA,TP,1608	
R148	2007-000074	R-CHIP	100ohm,5%,1/16W,DA,TP,1608	

7 Electrical Parts List

Loc. No.	Code No.	Description	Specification	Remarks
R149	2007-000074	R-CHIP	100ohm,5%,1/16W,DA,TP,1608	
R150	2007-000074	R-CHIP	100ohm,5%,1/16W,DA,TP,1608	
R151	2007-000074	R-CHIP	100ohm,5%,1/16W,DA,TP,1608	
R152	2007-000078	R-CHIP	1Kohm,5%,1/16W,DA,TP,1608	
R153	2007-000074	R-CHIP	100ohm,5%,1/16W,DA,TP,1608	
R154	2007-000074	R-CHIP	100ohm,5%,1/16W,DA,TP,1608	
R155	2007-000074	R-CHIP	100ohm,5%,1/16W,DA,TP,1608	
R156	2007-000074	R-CHIP	100ohm,5%,1/16W,DA,TP,1608	
R157	2007-000074	R-CHIP	100ohm,5%,1/16W,DA,TP,1608	
R158	2007-000074	R-CHIP	100ohm,5%,1/16W,DA,TP,1608	
R159	2007-000074	R-CHIP	100ohm,5%,1/16W,DA,TP,1608	
R160	2007-000102	R-CHIP	100Kohm,5%,1/16W,DA,TP,1608	
R162	2007-000090	R-CHIP	10KOHM,5%,1/16W,DA,TP,1608	
R165	2007-000084	R-CHIP	4.7Kohm,5%,1/16W,DA,TP,1608	
R166	2007-000084	R-CHIP	4.7Kohm,5%,1/16W,DA,TP,1608	
R167	2007-000090	R-CHIP	10KOHM,5%,1/16W,DA,TP,1608	
R168	2007-000074	R-CHIP	100ohm,5%,1/16W,DA,TP,1608	
R169	2007-000084	R-CHIP	4.7Kohm,5%,1/16W,DA,TP,1608	
R170	2007-000090	R-CHIP	10KOHM,5%,1/16W,DA,TP,1608	
R171	2007-000090	R-CHIP	10KOHM,5%,1/16W,DA,TP,1608	
R172	2007-000090	R-CHIP	10KOHM,5%,1/16W,DA,TP,1608	
R173	2007-000090	R-CHIP	10KOHM,5%,1/16W,DA,TP,1608	
R174	2007-000090	R-CHIP	10KOHM,5%,1/16W,DA,TP,1608	
R175	2007-000090	R-CHIP	10KOHM,5%,1/16W,DA,TP,1608	
R176	2007-000090	R-CHIP	10KOHM,5%,1/16W,DA,TP,1608	
R184	2007-000090	R-CHIP	10KOHM,5%,1/16W,DA,TP,1608	
R185	2007-000102	R-CHIP	100Kohm,5%,1/16W,DA,TP,1608	
R187	2007-000070	R-CHIP	0ohm,5%,1/16W,DA,TP,1608	
R188	2007-000070	R-CHIP	0ohm,5%,1/16W,DA,TP,1608	
R189	2007-000070	R-CHIP	0ohm,5%,1/16W,DA,TP,1608	
R190	2007-000070	R-CHIP	0ohm,5%,1/16W,DA,TP,1608	
R191	2007-000132	R-CHIP	180Kohm,5%,1/16W,DA,TP,1608	
R192	2007-000132	R-CHIP	180Kohm,5%,1/16W,DA,TP,1608	
R193	2007-000084	R-CHIP	4.7Kohm,5%,1/16W,DA,TP,1608	
R194	2007-000125	R-CHIP	3.9Kohm,5%,1/16W,DA,TP,1608	
R195	2007-000090	R-CHIP	10KOHM,5%,1/16W,DA,TP,1608	
R196	2007-000074	R-CHIP	100ohm,5%,1/16W,DA,TP,1608	
R197	2007-000084	R-CHIP	4.7Kohm,5%,1/16W,DA,TP,1608	
R198	2007-000084	R-CHIP	4.7Kohm,5%,1/16W,DA,TP,1608	
R199	2007-000090	R-CHIP	10KOHM,5%,1/16W,DA,TP,1608	
R201	2007-000090	R-CHIP	10KOHM,5%,1/16W,DA,TP,1608	
R202	2007-000071	R-CHIP	22ohm,5%,1/16W,DA,TP,1608	
R204	2007-000074	R-CHIP	100ohm,5%,1/16W,DA,TP,1608	
R208	2007-000075	R-CHIP	220ohm,5%,1/16W,DA,TP,1608	
R211	2007-000071	R-CHIP	22ohm,5%,1/16W,DA,TP,1608	
R212	2007-000071	R-CHIP	22ohm,5%,1/16W,DA,TP,1608	
R213	2007-000070	R-CHIP	0ohm,5%,1/16W,DA,TP,1608	
R214	2007-000074	R-CHIP	100ohm,5%,1/16W,DA,TP,1608	
R215	2007-000074	R-CHIP	100ohm,5%,1/16W,DA,TP,1608	
R216	2007-000070	R-CHIP	0ohm,5%,1/16W,DA,TP,1608	
R217	2007-000070	R-CHIP	0ohm,5%,1/16W,DA,TP,1608	

Loc. No.	Code No.	Description	Specification	Remarks
R219	2007-000070	R-CHIP	0ohm,5%,1/16W,DA,TP,1608	
R220	2007-000074	R-CHIP	100ohm,5%,1/16W,DA,TP,1608	
R221	2007-000074	R-CHIP	100ohm,5%,1/16W,DA,TP,1608	
R222	2007-000074	R-CHIP	100ohm,5%,1/16W,DA,TP,1608	
R223	2007-000074	R-CHIP	100ohm,5%,1/16W,DA,TP,1608	
R224	2007-000070	R-CHIP	0ohm,5%,1/16W,DA,TP,1608	
R225	2007-000070	R-CHIP	0ohm,5%,1/16W,DA,TP,1608	
R226	2007-000074	R-CHIP	100ohm,5%,1/16W,DA,TP,1608	
R227	2007-000074	R-CHIP	100ohm,5%,1/16W,DA,TP,1608	
R228	2007-000074	R-CHIP	100ohm,5%,1/16W,DA,TP,1608	
R229	2007-000074	R-CHIP	100ohm,5%,1/16W,DA,TP,1608	
R230	2007-000074	R-CHIP	100ohm,5%,1/16W,DA,TP,1608	
R231	2007-000074	R-CHIP	100ohm,5%,1/16W,DA,TP,1608	
R232	2007-000074	R-CHIP	100ohm,5%,1/16W,DA,TP,1608	
R233	2007-000074	R-CHIP	100ohm,5%,1/16W,DA,TP,1608	
R234	2007-000074	R-CHIP	100ohm,5%,1/16W,DA,TP,1608	
R235	2007-000124	R-CHIP	2.2Kohm,5%,1/16W,DA,TP,1608	
R236	2007-000134	R-CHIP	33Kohm,5%,1/16W,DA,TP,1608	
R237	2007-000090	R-CHIP	10KOHM,5%,1/16W,DA,TP,1608	
R238	2007-000309	R-CHIP	10ohm,5%,1/16W,DA,TP,1608	
R239	2007-000309	R-CHIP	10ohm,5%,1/16W,DA,TP,1608	
R240	2007-000072	R-CHIP	47ohm,5%,1/16W,DA,TP,1608	
R242	2007-000309	R-CHIP	10ohm,5%,1/16W,DA,TP,1608	
R243	2007-000071	R-CHIP	22ohm,5%,1/16W,DA,TP,1608	
R244	2007-000074	R-CHIP	100ohm,5%,1/16W,DA,TP,1608	
R245	2007-000084	R-CHIP	4.7Kohm,5%,1/16W,DA,TP,1608	
R246	2007-000084	R-CHIP	4.7Kohm,5%,1/16W,DA,TP,1608	
R247	2007-000088	R-CHIP	7.5Kohm,5%,1/16W,DA,TP,1608	
R248	2007-000084	R-CHIP	4.7Kohm,5%,1/16W,DA,TP,1608	
R249	2007-000084	R-CHIP	4.7Kohm,5%,1/16W,DA,TP,1608	
R250	2007-000084	R-CHIP	4.7Kohm,5%,1/16W,DA,TP,1608	
R251	2007-000102	R-CHIP	100Kohm,5%,1/16W,DA,TP,1608	
R253	2007-000090	R-CHIP	10KOHM,5%,1/16W,DA,TP,1608	
R254	2007-000074	R-CHIP	100ohm,5%,1/16W,DA,TP,1608	
R255	2007-000071	R-CHIP	22ohm,5%,1/16W,DA,TP,1608	
R259	2007-000070	R-CHIP	0ohm,5%,1/16W,DA,TP,1608	
R260	2007-000071	R-CHIP	22ohm,5%,1/16W,DA,TP,1608	
R261	2007-000071	R-CHIP	22ohm,5%,1/16W,DA,TP,1608	
R263	2007-000077	R-CHIP	470ohm,5%,1/16W,DA,TP,1608	
R264	2007-000077	R-CHIP	470ohm,5%,1/16W,DA,TP,1608	
R265	2007-000077	R-CHIP	470ohm,5%,1/16W,DA,TP,1608	
R266	2007-000077	R-CHIP	470ohm,5%,1/16W,DA,TP,1608	
R267	2007-000074	R-CHIP	100ohm,5%,1/16W,DA,TP,1608	
R268	2007-001167	R-CHIP	75ohm,5%,1/16W,DA,TP,1608	
R269	2007-000102	R-CHIP	100Kohm,5%,1/16W,DA,TP,1608	
R270	2007-000119	R-CHIP	560ohm,5%,1/16W,DA,TP,1608	
R273	2007-000070	R-CHIP	0ohm,5%,1/16W,DA,TP,1608	
R274	2007-000070	R-CHIP	0ohm,5%,1/16W,DA,TP,1608	
R275	2007-000070	R-CHIP	0ohm,5%,1/16W,DA,TP,1608	
R276	2007-000070	R-CHIP	0ohm,5%,1/16W,DA,TP,1608	
R277	2007-000070	R-CHIP	0ohm,5%,1/16W,DA,TP,1608	

7 Electrical Parts List

Loc. No.	Code No.	Description	Specification	Remarks
R278	2007-000090	R-CHIP	10KOHM,5%,1/16W,DA,TP,1608	
R279	2007-000090	R-CHIP	10KOHM,5%,1/16W,DA,TP,1608	
R297	2007-000090	R-CHIP	10KOHM,5%,1/16W,DA,TP,1608	
R298	2007-000090	R-CHIP	10KOHM,5%,1/16W,DA,TP,1608	
R299	2007-000090	R-CHIP	10KOHM,5%,1/16W,DA,TP,1608	
R307	2007-000076	R-CHIP	330ohm,5%,1/16W,DA,TP,1608	
R309	2007-001002	R-CHIP	510ohm,5%,1/16W,DA,TP,1608	
R310	2007-001002	R-CHIP	510ohm,5%,1/16W,DA,TP,1608	
R311	2007-001002	R-CHIP	510ohm,5%,1/16W,DA,TP,1608	
R315	2007-000076	R-CHIP	330ohm,5%,1/16W,DA,TP,1608	
R316	2007-000076	R-CHIP	330ohm,5%,1/16W,DA,TP,1608	
R317	2007-001002	R-CHIP	510ohm,5%,1/16W,DA,TP,1608	
R318	2007-000078	R-CHIP	1Kohm,5%,1/16W,DA,TP,1608	
R327	2007-000077	R-CHIP	470ohm,5%,1/16W,DA,TP,1608	
R328	2007-000078	R-CHIP	1Kohm,5%,1/16W,DA,TP,1608	
R330	2007-000074	R-CHIP	100ohm,5%,1/16W,DA,TP,1608	
R331	2007-000070	R-CHIP	0ohm,5%,1/16W,DA,TP,1608	
R332	2007-000070	R-CHIP	0ohm,5%,1/16W,DA,TP,1608	
R333	2007-000070	R-CHIP	0ohm,5%,1/16W,DA,TP,1608	
R338	2007-000070	R-CHIP	0ohm,5%,1/16W,DA,TP,1608	
R339	2007-000070	R-CHIP	0ohm,5%,1/16W,DA,TP,1608	
R340	2007-000070	R-CHIP	0ohm,5%,1/16W,DA,TP,1608	
R344	2007-000084	R-CHIP	4.7Kohm,5%,1/16W,DA,TP,1608	
R345	2007-000078	R-CHIP	1Kohm,5%,1/16W,DA,TP,1608	
R347	2007-000090	R-CHIP	10KOHM,5%,1/16W,DA,TP,1608	
R348	2007-000090	R-CHIP	10KOHM,5%,1/16W,DA,TP,1608	
R360	3301-001236	CORE-FERRITE BEAD	AB,60ohm,1.6x0.8x0.8mm,200mA,TP,H,0.7ohm	
R361	3301-001236	CORE-FERRITE BEAD	AB,60ohm,1.6x0.8x0.8mm,200mA,TP,H,0.7ohm	
R362	3301-001236	CORE-FERRITE BEAD	AB,60ohm,1.6x0.8x0.8mm,200mA,TP,H,0.7ohm	
RA201	2011-000002	R-NETWORK	22ohm,5%,63mW,L,CHIP,8P,TP	
RA202	2011-000002	R-NETWORK	22ohm,5%,63mW,L,CHIP,8P,TP	
RA203	2011-000002	R-NETWORK	22ohm,5%,63mW,L,CHIP,8P,TP	
RA204	2011-000002	R-NETWORK	22ohm,5%,63mW,L,CHIP,8P,TP	
RA205	2011-000002	R-NETWORK	22ohm,5%,63mW,L,CHIP,8P,TP	
RA206	2011-000002	R-NETWORK	22ohm,5%,63mW,L,CHIP,8P,TP	
RA207	2011-000002	R-NETWORK	22ohm,5%,63mW,L,CHIP,8P,TP	
RA208	2011-000002	R-NETWORK	22ohm,5%,63mW,L,CHIP,8P,TP	
RA209	2011-000002	R-NETWORK	22ohm,5%,63mW,L,CHIP,8P,TP	
RA210	2011-000002	R-NETWORK	22ohm,5%,63mW,L,CHIP,8P,TP	
RA211	2011-000002	R-NETWORK	22ohm,5%,63mW,L,CHIP,8P,TP	
RA212	2011-000002	R-NETWORK	22ohm,5%,63mW,L,CHIP,8P,TP	
RA213	2011-000002	R-NETWORK	22ohm,5%,63mW,L,CHIP,8P,TP	
RA214	2011-000002	R-NETWORK	22ohm,5%,63mW,L,CHIP,8P,TP	
X101	2801-003667	CRYSTAL-SMD	14.3182MHZ,50PPM,28-AAN,16,500HM,TP	
X201	2804-001474	OSCILLATOR-CLOCK	14.31818MHZ,100PPM,30PF,TP,3.3V,15MA	
ZD101	0403-000579	DIODE-ZENER	BZX84C5V1,5.1V,5%,200mW,SOT-23	
ZD102	0403-000579	DIODE-ZENER	BZX84C5V1,5.1V,5%,200mW,SOT-23	
ZD103	0403-000579	DIODE-ZENER	BZX84C5V1,5.1V,5%,200mW,SOT-23	
ZD104	0403-000579	DIODE-ZENER	BZX84C5V1,5.1V,5%,200mW,SOT-23	
ZD105	0403-000579	DIODE-ZENER	BZX84C5V1,5.1V,5%,200mW,SOT-23	
ZD106	0403-000579	DIODE-ZENER	BZX84C5V1,5.1V,5%,200mW,SOT-23	

7-2 Others

Loc. No.	Code No.	Description	Specification	Remarks
CIS	BN39-00114A	CBF-SIGNAL	NL150MO,15P/15P,2990,1830MM,UL2990,IVORY,D-SUB	
CIS	BN44-00029A	INVERTER	SIC1801,4LAMP,SIC1801,18.1,14V DC,160x45x17	
CIS	BN41-00045A	PCB MAIN	CEZANNE-II,FR-4,4,-,1.6T,117.0*172.4*1.6,CN,-,-,CN17MS,-,-,1.6+223x118.9,-,-,-	
CN301+PAN	BN39-00102A	CBF-HARNESS	CN17MSS,UL1571,UL/CSA,30P,90MM,BLU/WHT,AWG30,DF14-30S-1.25C,F1-X30H,-,-,-,-,-	
CN302+INV	BN39-00002A	CBF-HARNESS	-60,BLU/WHT,-,26,-	

Memo

8 Block Diagram

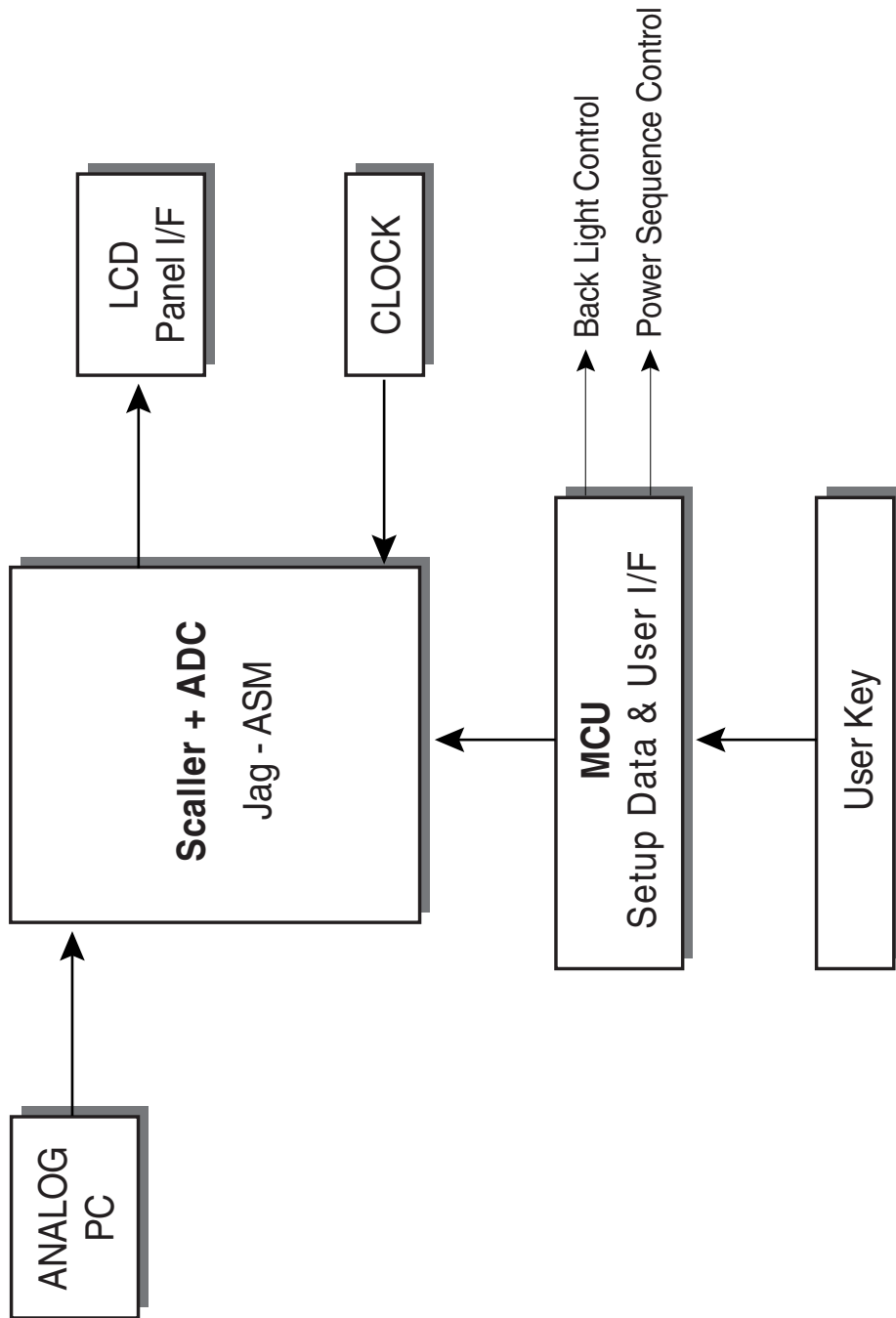

Memo

9 Wiring Diagram

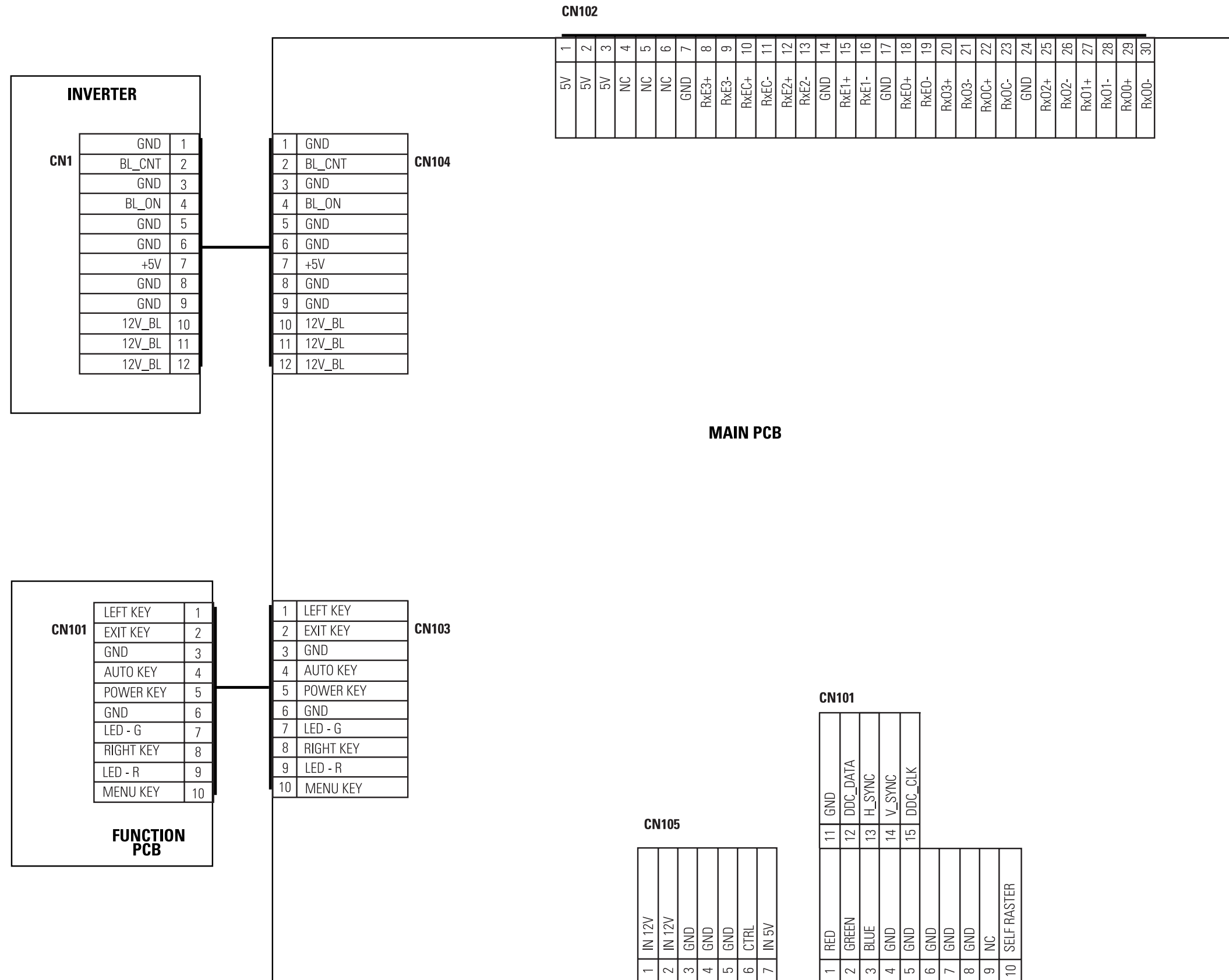

Memo

10 Schematic Diagrams

10-1 Main Part Schematic Diagram

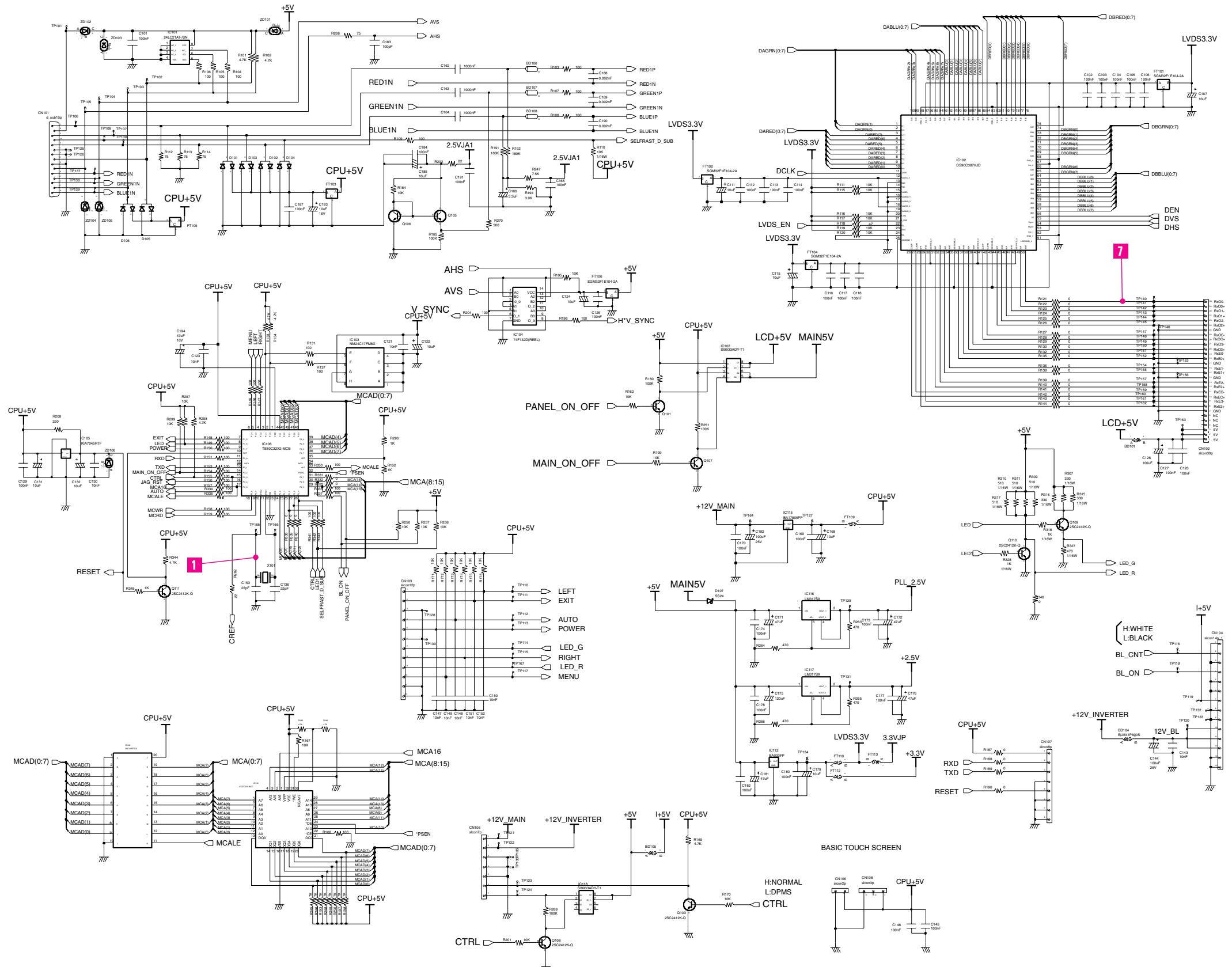

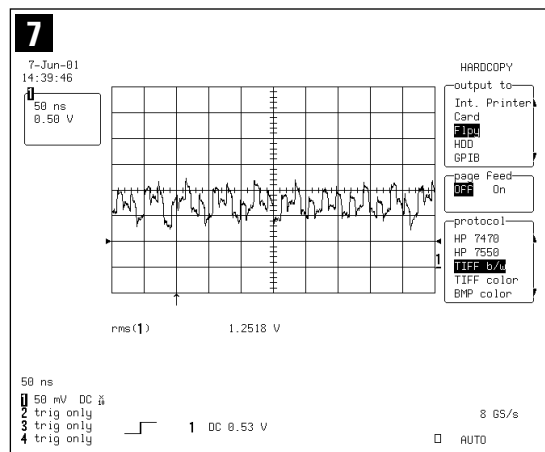
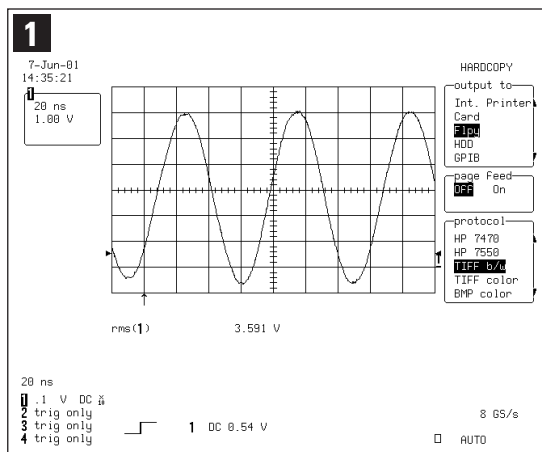

10-2 Main Part Schematic Diagram

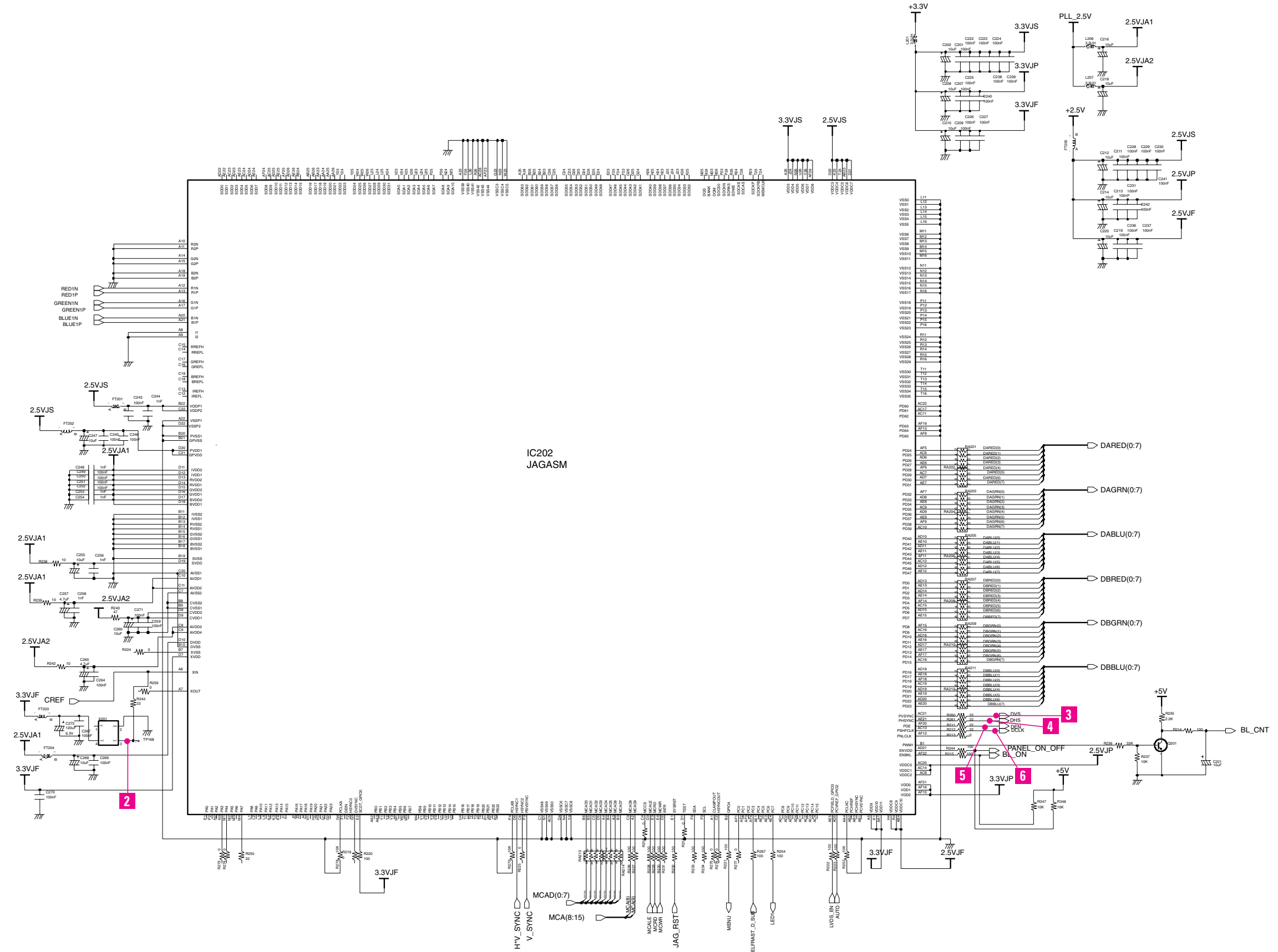

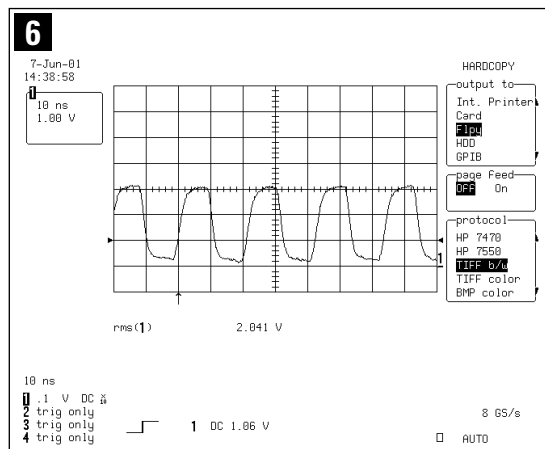
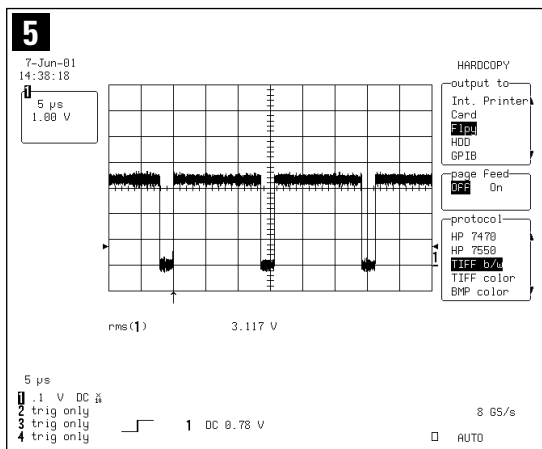
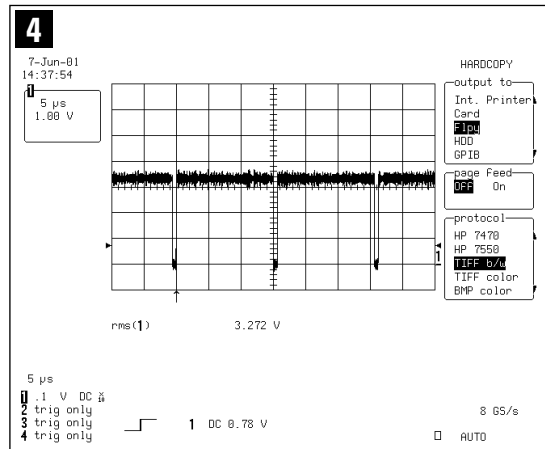
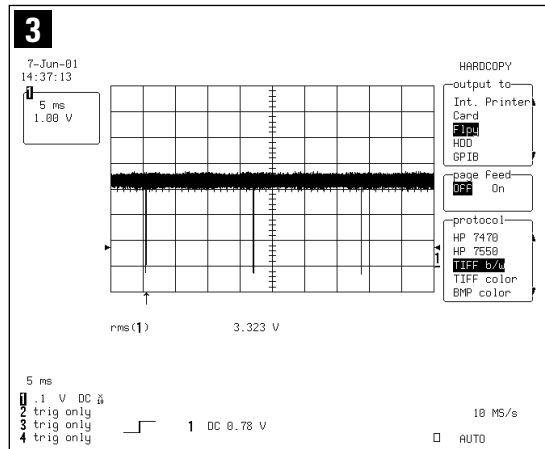
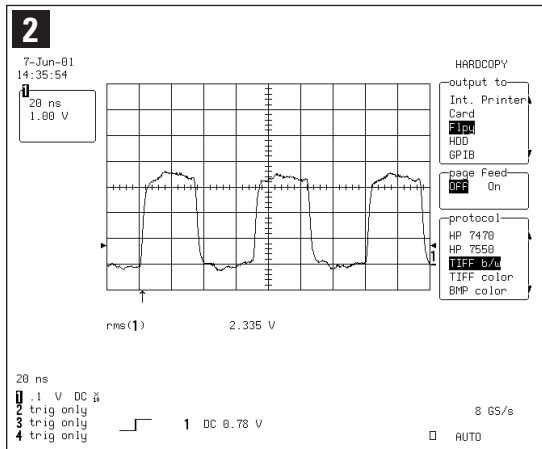

11 Panel Description

Maker	VENDOR P/N	PANEL_ABB	Description
SEC	LT140X1-002	SA	
SEC	LT150XS-L01	SB	L01
SEC	LT150XS-L01-B	SC	L01-B
SEC	LTM150XS-L02	SD	L02
SEC	LT181E2-132	SE	E2(18.1)-132
SEC	LT150XS-T01	SF	T01
SEC	LTM181E3-132	SG	E3(18.1)
SEC	LT170E2-131	SH	E2
SEC	LT181E2-131	SJ	E2-131
SEC	LTM170E4-L01	SK	E4
SEC	LTM240W1-L01	SL	L01
SEC	LTM213U3-L01	SM	L01
TOSHIBA	LTM15C419	TA	419
TOSHIBA	LTM15C423	TB	423
TOSHIBA	LTM18C161	TC	
HANNSTAR	HSD150MX41A	NA	
TORISAN	TM150XG-22L03	RA	
SHARP	LQ181E1DG11	PA	
HITACHI	TX38D12VC0CAA	HA	
IBM	ITSX94S	IA	
UNIPAC	UM170E01	UA	
SEC	LTM170EH-L01	SS	
Acer	L170 E3-1	AA	

Memo